



MAHARASHTRA STATE BOARD OF TECHNICAL EDUCATION
(Autonomous)
(ISO/IEC-27001-2005 Certified)

WINTER- 2018 Examinations

Subject Code: 22328

Model Answer

Page 1 of 23

Important suggestions to examiners:

- 1) The answers should be examined by key words and not as word-to-word as given in the model answer scheme.
- 2) The model answer and the answer written by candidate may vary but the examiner may try to assess the understanding level of the candidate.
- 3) The language errors such as grammatical, spelling errors should not be given more importance. (Not applicable for subject English and communication skills)
- 4) While assessing figures, examiner may give credit for principle components indicated in a figure. The figures drawn by candidate and model answer may vary. The examiner may give credit for any equivalent figure drawn.
- 5) Credits may be given step wise for numerical problems. In some cases, the assumed constant values may vary and there may be some difference in the candidate's answers and model answer.
- 6) In case some questions credit may be given by judgment on part of examiner of relevant answer based on candidate understands.
- 7) For programming language papers, credit may be given to any other program based on equivalent concept.

Q.1	Attempt any FIVE of the following :	10 Marks
a)	State different types of holders used in wiring installation.	
Ans	Following types of holders used in wiring installation: 1. Pendent Holder 2. Batten Holder 3. Angle holder 4. Screwed holder	(Any Two expected: 2 Marks)
b)	State the types of protections provided by MCB.	
Ans	The types of protections provided by MCB: 1. MCB provides short circuit protection. 2. MCB provides overload protection	(2 Marks)
c)	State the material used for making (1) Magnetic Core (2) Fuse element	
Ans	The material used for making of: (1) Magnetic Core : Iron, cobalt, Nickel, CRGO, HRGO , silicon steel (2) Fuse Element: Tin- lead wire, Tinned copper wire (Any one material expected for each)	(2 Marks)
d)	State gaseous and liquid insulating material. (one each)	
Ans	i) Gaseous insulating material : 1. Air 2. Nitrogen 3. Hydrogen 4. SF6	(Any one expected : 1 Mark)



	<p>ii) liquid insulating material: (Any one expected : 1 Mark)</p> <ol style="list-style-type: none">1. Transformer oil2. Capacitor oil3. Cable oil4. Pyranol5. Savotal6. Savol7. Vegetable oil8. Silicon liquids
<p>e) State the type of insulating materials under Class Y and Class B. (any two each).</p>	
<p>Ans</p>	<p>The type of insulating materials under Class Y : (Any Two expected : 1 Mark)</p> <ol style="list-style-type: none">1. Cotton2. Silk3. Paper4. Rubber5. PVC <p>The type of insulating materials under Class B: (Any Two expected : 1 Mark)</p> <ol style="list-style-type: none">1. Backelite2. Impregnated varnish3. Mica4. Fiber glass5. Asbestos
<p>f) Draw circuit diagram for one lamp controlled with one switch.</p>	
<p>Ans</p>	<p>circuit diagram for one lamp controlled with one switch: (2 Marks)</p> <div style="text-align: center;"><p>wiring diagram Single line diagram or equivalent figure</p></div>



MAHARASHTRA STATE BOARD OF TECHNICAL EDUCATION
(Autonomous)
(ISO/IEC-27001-2005 Certified)

WINTER- 2018 Examinations

Subject Code: 22328

Model Answer

Page 3 of 23

g)	Define earthing. State its types.	
Ans	Definition of earthing: <ul style="list-style-type: none">➤ Earthing means connecting the metal body of electrical device to the general mass of earth by a wire of negligible resistance. <p style="text-align: center;">OR</p> <ul style="list-style-type: none">➤ Earthing means connecting the metal body of electrical device to the earthing pit. <p style="text-align: center;">OR</p> <ul style="list-style-type: none">➤ Earthing is the processes of connection to the specific part of installation with earth conductive surface. Types of Earthing : <ul style="list-style-type: none">i) Plate type earthingii) Pipe type earthingiii) Rod type earthingiv) Strip earthingv) Water main earthing	(1 Mark) (1 Mark)
Q.2	Attempt any THREE of the following :	12 Marks
a)	State any Four IE Rules regarding electric safety.	
Ans:	IE Rules regarding electric safety: (Any Four expected : 1 Mark each: Total : 4 Marks) <ol style="list-style-type: none">1. IE Rule 3 : Authorization2. IE Rule 29 : Construction and maintenance of electrical supply line and apparatus3. IE Rule 30: Service line and apparatus on consumers premises.4. IE Rule 31: IE Rule 30: Cut out on consumer premises.5. IE Rule 32: Identification of earthed and earthed neutral conductor and position of switches and cut outs therein6. IE Rule 33: Earthed termination consumers premises.7. IE Rule 34: Accessibility of bare conductors8. IE Rule 35: Danger boards notices9. IE Rule 36: Handling of electrical supply line and apparatus.10. IE Rule 37: Supply to vehicles, cranes etc.11. IE Rule 38: Cable for portable or transportable apparatus.12. IE Rule 41: Distinction of different circuits.13. IE Rule 41A: Distinction of the installations having more than one feed14. IE Rule 42: Accidental charges	



	<p>15. IE Rule 43: Provision applicable to protective equipment's.</p> <p>16. IE Rule 44: Instruction for restoration of persons suffering from electrical shock.</p> <p>17. IE Rule 44A: Intimation of accidents</p> <p>18. IE Rule 45: Precautions to be adopted by consumers, owners, occupiers, electrical contractors, electrical workman and suppliers.</p> <p>19. IE Rule 46: Periodical inspection and testing of consumers installation.</p> <p>20. IE Rule 48: Precaution against leakage before connection.</p> <p>21. IE Rule 49: Leakage on consumers premises</p> <p>22. IE Rule 50: Supply and use of energy.</p> <p>23. IE Rule 54: Declared voltage of supply to consumers</p> <p>24. IE Rule 55: Declared frequency of supply to consumer</p> <p>25. IE Rule 56: Sealing of meters and cutouts</p> <p>26. IE Rule 60: Test for resistance of insulation</p> <p>27. IE Rule 61: Connection with earth</p>
b)	Explain the suitability of aluminium as an electrical conductor with respect to its mechanical and electrical properties.
Ans:	<p>Following are requirements of conductor:-</p> <p style="text-align: right;">(Any Four expected : 1 Mark each: Total : 4 Marks)</p> <p>i) High conductivity :</p> <p>Material should have high conductivity, So that</p> <ul style="list-style-type: none">➤ cross section of conductor (size) reduces,➤ Copper losses reduces,➤ So Efficiency increases➤ Voltage drop reduces,➤ So Regulation gets improved <p>ii) High mechanical strength:</p> <p>Material should have sufficiently high mechanical strength to with stand against</p> <ul style="list-style-type: none">➤ Rough handling during transportation & Stringing,➤ Wind Pressure,➤ Ice loading and➤ Severe climatic condition <p>iii) Flexibility: Material should be flexible for</p> <ul style="list-style-type: none">➤ Easy handling and➤ storage



- iv) **Weight:** Material should be light in weight to reduce
 - Transportation & handling cost.
- v) **High resistance to corrosion:** Material should have high resistance to corrosion
 - To avoid rusting
- vi) **Brittleness:** Material should not be brittle.
 - So that it will not easily cut after twisting.
- vii) **Temperature coefficient of resistance:** Material should have low temperature coefficient of resistance.
- viii) **Availability & cost:** Material should be easily available & less costly.
- ix) **Scrap Value:** Material should have high scrap value.

OR

Properties of Aluminium

1. Electrical conductivity is next to that of copper
2. Electrical resistivity is $2.699 \mu\text{ohm cm}$ at 20°
3. Good conductor of heat and electricity.
4. Temperature coefficient of resistance of resistance is 0.00412.
5. It forms useful alloys with iron, copper, zinc and other metals.
6. It is ductile and malleable
7. Melting point is 658°C
8. Boiling point is 1820°C
9. Specific gravity is 2.7
10. High resistance to corrosion.

- c) **Select insulating materials for following parts :**
- (i) **Insulation between heating element and base plate of electric iron.**
 - (ii) **Insulation used over copper or aluminium conductor used for making coils.**
 - (iii) **Transformer bushings.** (iv) **Insulation between transmission line and pole.**

Ans:

(1 Mark each parts : Total : 4 Marks)

S.No	Parts	Insulating Materials
i	Insulation between heating element and base plate of electric iron.	Mica
ii	Insulation used over copper or aluminium conductor used for making coils.	Impreganted cotton, enameled insulation. silk or resins
iii	Transformer bushings	Porcelain
iv	Insulation between transmission line and pole.	Porcelain

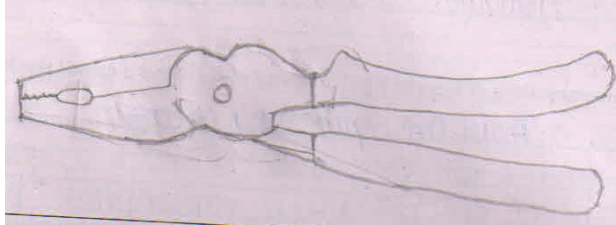
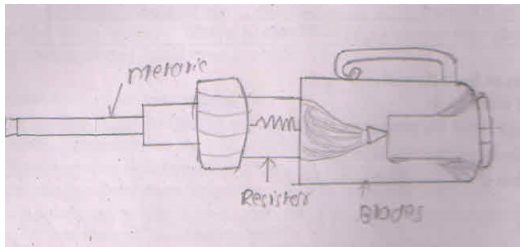

d)	Compare casing capping wiring with concealed wiring. (any four points)																														
Ans:	<p>Compare casing capping wiring with concealed wiring:</p> <p style="text-align: center; color: red;">(Any Four point expected: 1 Mark each : Total 4 Marks)</p> <table border="1" style="width: 100%; border-collapse: collapse; text-align: center;"> <thead> <tr> <th style="width: 10%;">S.No</th> <th style="width: 35%;">Point</th> <th style="width: 20%;">Casing Capping</th> <th style="width: 35%;">Concealed wiring</th> </tr> </thead> <tbody> <tr> <td>1</td> <td>Appearance</td> <td>Better</td> <td>Best</td> </tr> <tr> <td>2</td> <td>Life</td> <td>High</td> <td>Very High</td> </tr> <tr> <td>3</td> <td>Repair & Maintenance</td> <td>Simple</td> <td>More difficult</td> </tr> <tr> <td>4</td> <td>Expansion</td> <td>Possible</td> <td>More difficult</td> </tr> <tr> <td>5</td> <td>Cost</td> <td>High</td> <td>Very High</td> </tr> <tr> <td>6</td> <td>Mechanical & Electrical Safety</td> <td>Medium</td> <td>High</td> </tr> </tbody> </table>			S.No	Point	Casing Capping	Concealed wiring	1	Appearance	Better	Best	2	Life	High	Very High	3	Repair & Maintenance	Simple	More difficult	4	Expansion	Possible	More difficult	5	Cost	High	Very High	6	Mechanical & Electrical Safety	Medium	High
S.No	Point	Casing Capping	Concealed wiring																												
1	Appearance	Better	Best																												
2	Life	High	Very High																												
3	Repair & Maintenance	Simple	More difficult																												
4	Expansion	Possible	More difficult																												
5	Cost	High	Very High																												
6	Mechanical & Electrical Safety	Medium	High																												
Q.3	Attempt any THREE of the following :		12 Marks																												
a)	Draw and explain the use of : (i) Combination plier (ii) Tester (iii) Wire Striper (iv) Hammer																														
Ans:	<p>(i) Combination plier : (1 Mark)</p> <p>It is used for cutting of wires, gripping operation by hand, twisting wires and other different operations required in electrical work</p> <div style="text-align: center;">  <p>or equivalent figure</p> </div> <p>(ii) Tester : (1 Mark)</p> <p>To verify the live main or supply verification</p> <div style="text-align: center;">  <p>or equivalent figure</p> </div>																														



(iii) Wire Stripper :

(1 Mark)

To cut the wire & remove the insulation of the wire.

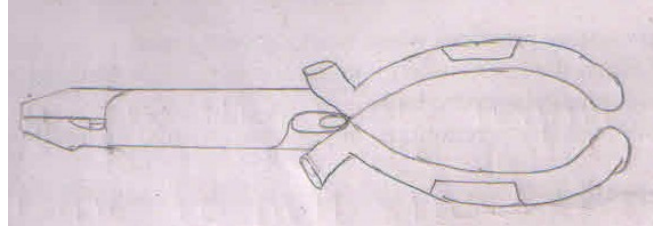

or equivalent figure

(iv) Hammer :

(1 Mark)

To fix and extract screws, to apply pressure & weight, Bending of wires

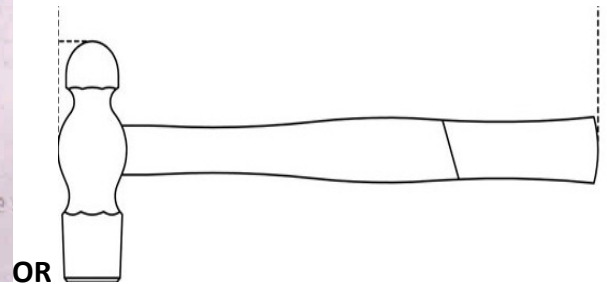
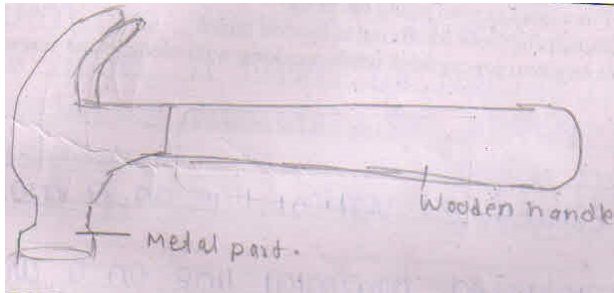

OR

Or any other type of Hammer.

Explain MCB and ELCB with connection diagram supplying single phase load.

Ans:

Connection diagram:

(Diagram : 2 Mark & Explanation : 2 Marks)

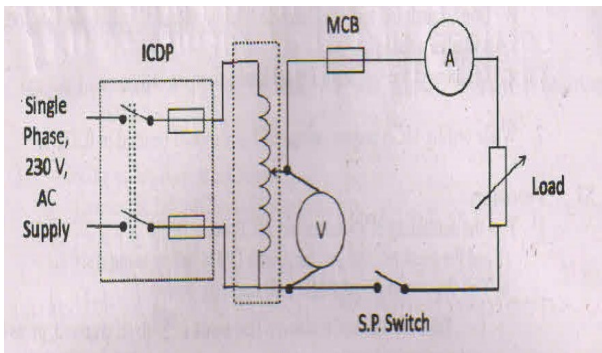

OR

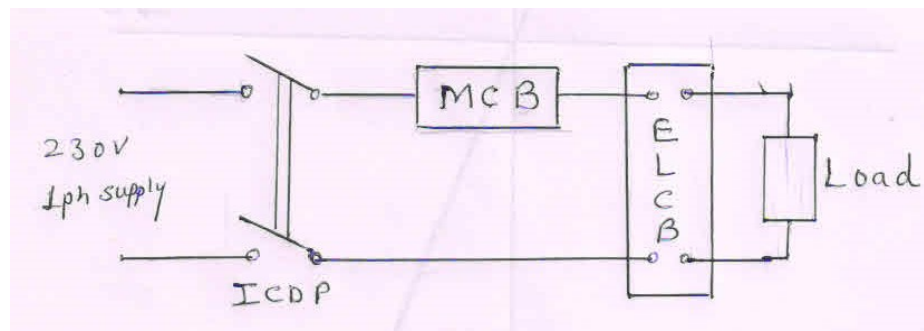
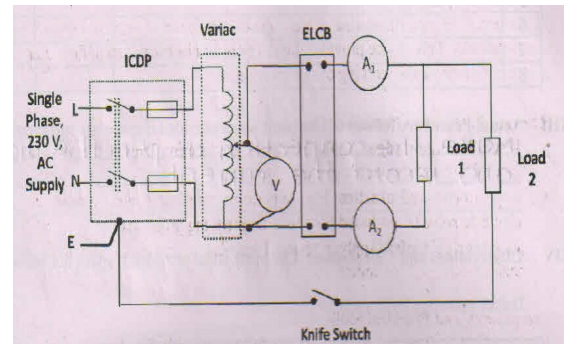

OR equivalent Figure



	<p>Explanation:</p> <ul style="list-style-type: none">➤ MCB provides short circuit protection.➤ MCB provides overload protection➤ ELCB provides earth fault protection.➤ MCB is in series with load and ELCB is across the supply. <p>ELCB:-</p> <p>An Earth Leakage Circuit Breaker (ELCB) is a device used to directly detect currents leaking to earth from an installation and cut the power and avoid the person from getting shock.</p> <p>There are two types of ELCBs:</p> <ol style="list-style-type: none">1. Voltage Earth Leakage Circuit Breaker (voltage-ELCB)2. Current Earth Leakage Circuit Breaker (Current-ELCB). <p style="text-align: center;">OR</p> <p>Earth leakage circuit breaker is a safety device used in electrical installations with high earth impedance to prevent shocks and disconnect power under earth fault conditions. Works on principle of relaying when the current in the earth path exceeds a set value. ELCB is used for protection against electric leakage in the circuit of 50 Hz or 60 Hz , rated voltage single phase 230 V, 3 ph. 400 v. Rated current up to 60 Amp. When the earth fault occurs, the ELCB cuts off the power within the time of 0.1 sec. automatically to protect the personnel.</p>
	<p>c) State two applications of : (i) PVC paper (ii) Porcelain with type of class based on withstand temperature is insulating material.</p>
Ans:	<p>(i) Application of PVC paper : (2 Marks)</p> <ol style="list-style-type: none">1. It is used in slot lining or motor winding insulation purpose2. For Insulation of Transformer winding <p>(ii) Application of Porcelain : (1 Mark)</p> <ol style="list-style-type: none">1. Mainly used for manufacturing of all types of insulators used in transmission and distribution lines.2. Transformer bushing3. For thermal & Electrical insulation in electrical oven <p>Porcelain with type of class based on withstand temperature :</p> <ul style="list-style-type: none">➤ H' & 'C' Class of insulation i.e. 180⁰ and above 180⁰C (1 Mark)

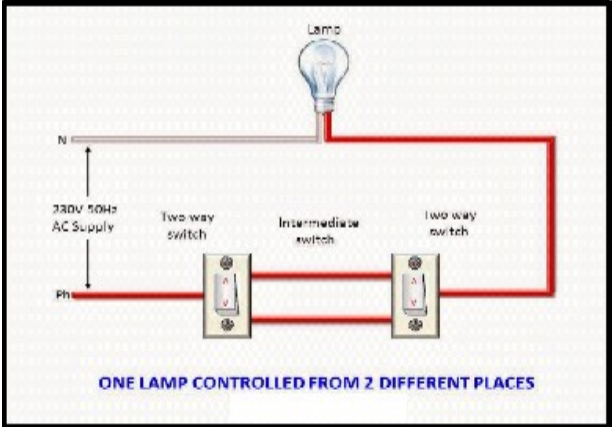
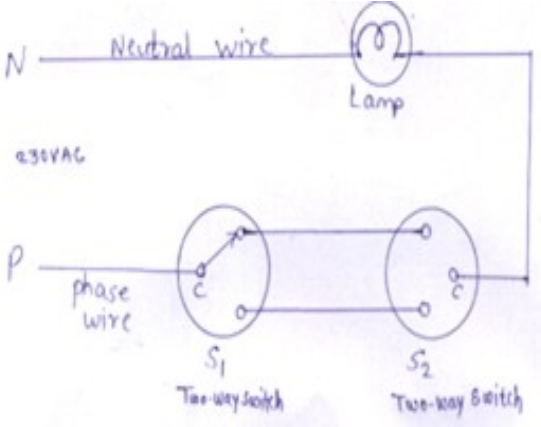

d)	Draw wiring diagram for connection of one lamp controlled from two places. 'State the application of this connection.	
Ans:	<p>one lamp controlled from two places:</p>  <p>OR</p> <p>or equivalent figure</p> <p>Application one lamp controlled from two places:</p> <ol style="list-style-type: none"> 1. For Stair case wiring 2. Hospital Wiring (For operating the lamp in room and nursing station) 3. Bedroom Lighting. 	<p>(Figure: 2 Mark & Application: 2 Mark)</p> 
Q.4	Attempt any THREE of the following : 12 Marks	
a)	State any two advantages of MCB over Fuse. State the standard specifications of MCB available in the market.	
Ans:	<p>Following advantages of MCB over Fuse: (Any Two advantages expected: 1 Mark each)</p> <ol style="list-style-type: none"> 1. No need of replacement of fuse wire. 2. Manually restore of supply is simple. 3. Fault understanding by visual inspection 4. More safe than fuse <p>The standard specifications of MCB available in the market:</p> <p style="text-align: right;">(Any Two advantages expected: 1 Mark each)</p> <ol style="list-style-type: none"> 1. Single pole 2. Two pole 3. Three pole 4. Four pole 5. For available current rating : 0.5A, 1A, 1.6A,2A,5A, 6A, 10A,16A,20A, 25A, 30A, 32A, 40A, 50A, 60A and 63A 6. 250V and 450 v 	



b)	Explain HRGO and CRGO. State benefits of CRGO for manufacturing of core.
Ans:	<p>i) HRGO (Hot –rolled grain oriented steel): (1 Mark)</p> <ul style="list-style-type: none">➤ To minimize the size of machine flux density should be high with small magneto motive force (MMF). Due to this iron loss will be less . All ferromagnetic material have the crystal line structure which is particular direction along which it offers high permeability.➤ So Magnetizing will be simple. Sheath steel which has been rolled, so as to give the orientation to all the crystals is called as the grain oriented steel. Due to the grain orientation hysteresis loss will be less.➤ Magnetizing property will be simple.➤ For manufacturing hot rolling process is used for the material so called as hot rolled grain oriented steel(HRGO) <p>ii) CRGO (Cold –rolled grain oriented steel): (1 Mark)</p> <ul style="list-style-type: none">➤ The grain orientation of silicon steel is obtained by special techniques named cold rolling➤ The process is without any high temperature. So this material is called as the cold rolled grain oriented steel.➤ The cost of CRGO is more than HRGO <p>Benefits of CRGO for manufacturing of core:</p> <p style="text-align: right;">(Any Two Benefits expected: 1 Mark each)</p> <ol style="list-style-type: none">1. CRGO is generally used for high flux density with small magneto motive force to minimize the size of the machine.2. Due to less size of the machine iron loss will be less.3. Permeability is high, so magnetizing will be simple.4. Due to grain orientation hysteresis loss will be reduces.5. In CRGO the percentage of iron loss is less than HRGO.6. Magnetic properties of CRGO material can be regained by heating of that magnetic material7. The Chemical composition of G.O. steel has a higher percentage of silicon which in turn increases the resistance compared to regular steel which reduces eddy currents.



c) State the insulating materials used in motor. Write temperature class and withstand temperature ranges for them.

Ans: **The insulating materials used in motor are as follows:**
(Any Four material expected : 1/2 each point)

1. Cotton,
2. Silk, or paper,
3. Press board,
4. Resins
5. PVC
6. Cellulose-Fiber,
7. Enameled coating, etc

Temperature class and withstand temperature ranges for them: (2 Marks)
(any four types expected)

S.No	Insulation Classes	Maximum permissible temperature ($^{\circ}\text{C}$)	Materials
1	Class-Y	90°	cotton, silk, or paper, press board, vulcanized fiber, wood, cellulose-Fiber, PVC VIR etc without impregnating substance
2	Class- A	105°	cotton, silk, or paper, press board, vulcanized fiber, wood, with impregnated varnish or insulation oil
3	Class- E	120°	Superior wire enamels based on polyvinyl ferrul or epoxy resins, moulding with cellulose fibers, cotton fabric and paper laminates.
4	Class- B	130°	Glass fiber, asbestos, Mica, Varnished glass fiber textile, built up mica
5	Class- F	155°	adhesives, silicone, and alkyd-resin varnish of higher thermal endurance



				and: Glass fiber, asbestos, Mica, Varnished glass fiber textile, built up mica
6	Class- H		180 ⁰	Combination of materials such as mica, glass, fiber, asbestos, with suitable high resistive bonding material like silicon
7	Class- C		Over 180 ⁰	Mica, porcelain, ceramics, glass quartz, asbestos, treated glass fiber or treated asbestos. etc.

d) State the procedure for laying / installation of underground cable.

Ans: 1) Direct laying Cable: or Trench laying method: (Any one method of laying of underground cable expected: Figure: 2 Mark & Explanation: 2 Mark)

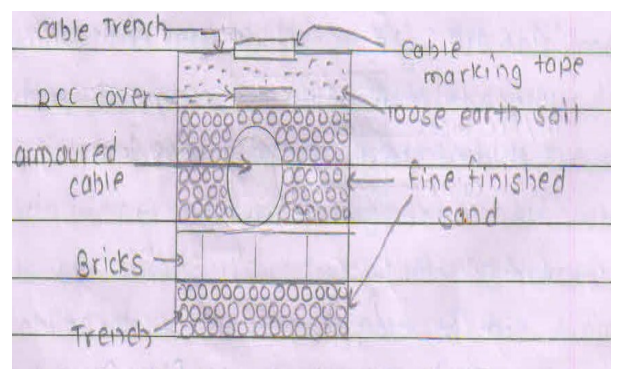
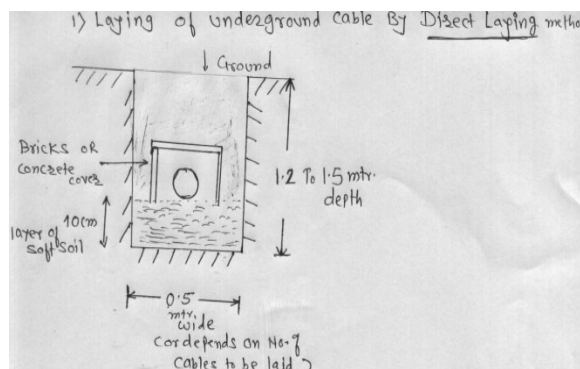

Procedure:

- For laying of a cable trench about 1.5m deep and 0.5m wide is made along the cable route.
- A layer of 10 cm thickness of soft soil is spread throughout the cable route in trench.
- The cable is laid on this soft soil (bed)
- A wall of bricks (concrete cover) is provided on either side or top of cable along the length of cable for better mechanical protection.
- Another layer of soft sand, about 10 cm thicknesses is spread throughout its cable length.
- Refill the remaining trench with the help of remaining soil up to ground level.
- While crossing roads (public-crossing) cable is laid through cement pipe or DWC pipe,



instead of bricks for better mechanical protection.

- When more than 1 cable is to be laid in the same trench, then minimum 30 cm spacing is provided between 2 cables and gap is filled by sand.
- The spacing is kept between 2 cables to reduce the effect of mutual heating and also fault occurring on one cable does not damage the adjacent cable.
- Only armored cables are used in this method.

2) Draw in cable laying System or Duct laid cable laying system:

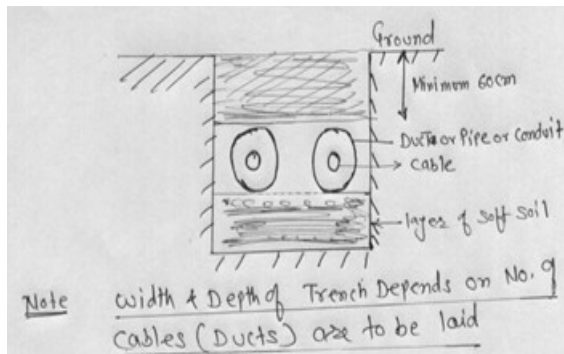

OR

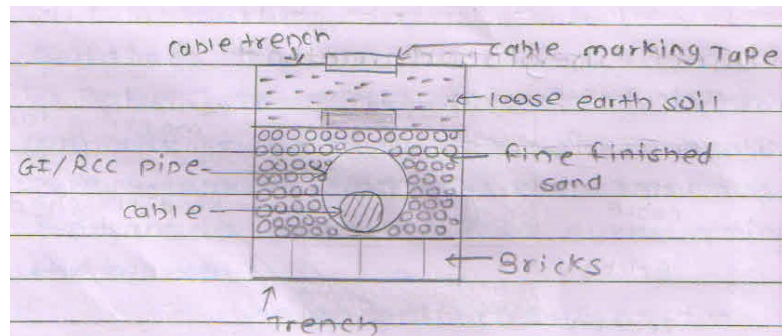
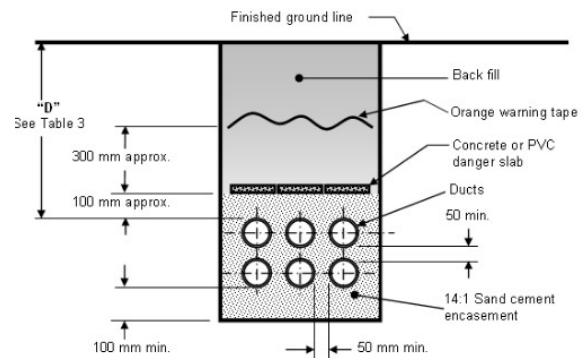

Procedure:

- A trench of minimum 60cm deep is made along with cable route.
- Width of trench depends on number of conduits to be laid.
- Separate pipes are provided for each cable.
- Spacing between 2 cables (conduit) is between 25 cm to 75 cm.
- Diameter of pipe is **2 to 3 cm**, greater than cable diameter for easy handling of cable.
- Pipe used may be cement pipe, DWC pipe or ducts of **glad** stone are used.
- For Maintenance and other cable work, man-holes are provided at suitable



distance.

- Size of man-holes should be large enough to allow a person to enter into duct without difficulty.
- Unarmored cables are used in this type.

3) Solid system or through Laying method:

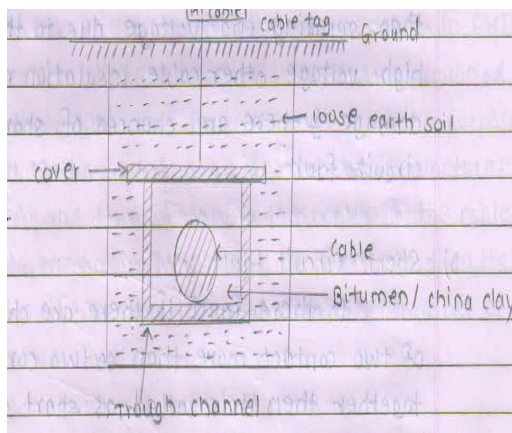

OR

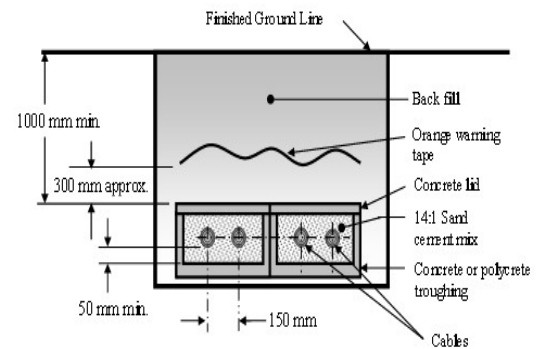

Procedure:

- In this method of laying, the cable is laid in open pipes or troughs dug out in earth along the cable route.
- The troughing is of cast iron, stoneware, asphalt or treated wood.
- After the cable is laid in position, the troughing is filled with a bituminous or asphaltic compound and covered over.
- Cables laid in this manner are usually plain lead covered because troughing affords good mechanical protection.

e) **State the procedure for testing of earth pit resistance with necessary diagrams.**

Ans:

(Any one method of laying of underground cable expected: Figure: 2 Mark & Explanation: 2 Mark)

Following procedure (Method) for testing of earth pit resistance with necessary diagrams.

- 1) **Earth Tester** : i) Three point method ii) Four point method
- 2) By Potential drop method
- 3) Water tap method



1) earth resistance measurement for Earth Tester

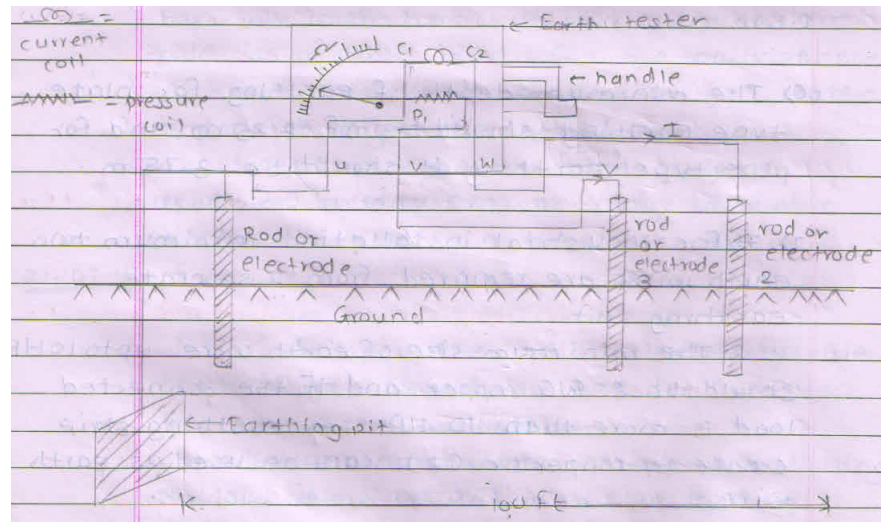

- The earth tester has two coils named current coil and pressure coil.
- The three GI rods or iron rods (electrode) are embedded in the ground. The distance between the electrode no.1 and no.2 is kept 100 ft (30m). The connections for this electrode are made as shown in figure.
- Initially electrode no.3 is kept or embedded in the ground near to electrode no.2.
- The earthing pit connection is done to the rod no.1. The procedure for earth resistance measurement test is as below.
- Make the connection as shown in figure.
- Rotate the handle of earth tester near to 100 to 120 RPM and measure the first reading of earth resistance.
- Remove the rod no.3 and place at the distance of 90 ft from the rod no.1 and embed in the ground. Rotate the handle of earth tester at 100 to 120 RPM and measure the earth resistance.
- The same procedure is repeated and rod no.3 is kept at 80 ft., 70 ft, 70ft, 50 ft, 40 ft, 30 ft, 20 ft, 10 ft and 0 ft, and by rotating handle of earth tester separate readings are taken.
- The graph is plotted between the earth resistance value and the distance between rod no.1 and rod no.3.
- The earth resistance of the earth pit should be which is specified by Indian electricity rule

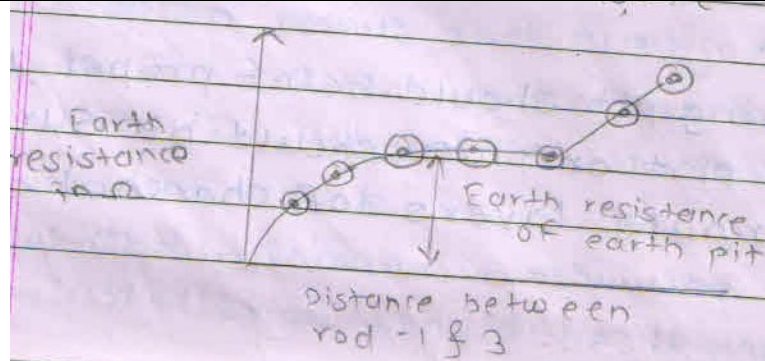

2) By Potential Drop Method:

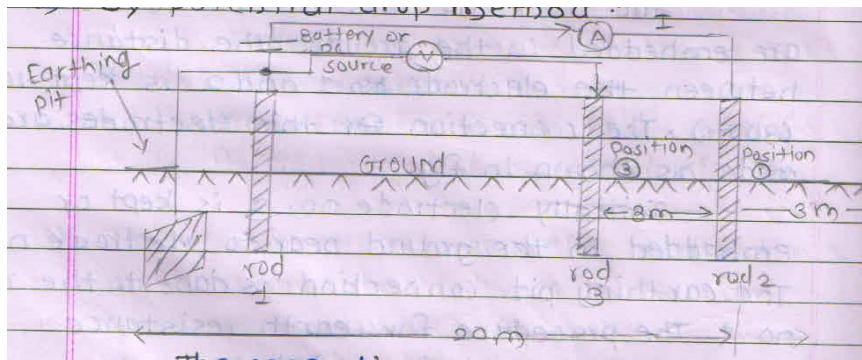

or equivalent figure

- The connections are as shown in figure.
- In potential drop method external DC source battery or hand driven generator is used as DC source.
- The current flowing through the rod no.1 and rod no.2 current electrodes is measured
- At same time voltage across the rod No.1 and rod No.3 is measured by apply the ohms law. $R = \frac{V}{I}$ is calculated. The procedure is as below
- Make the connections as shown in figure for observation no.1. Keep the rod no.3 near to the rod no.2 (at 20m distance) from rod no.1 measure the voltage and current, calculate resistance.
- The rod no.3 is kept at position no.2 (23 m from rod no.1) and measure the voltage and current and calculate resistance.
- Keep the distance between rod no.1 and rod no.3 (17 m in the ground). Measure the voltage and current calculate the resistance.
- For the 3 observation 3 resistances are calculated the mean resistance of that is declared as earth resistance of that earthing pit.



- Due to external DC source there are chances of electrical shock so that skilled labours can be this test

3) By Water tap Method:

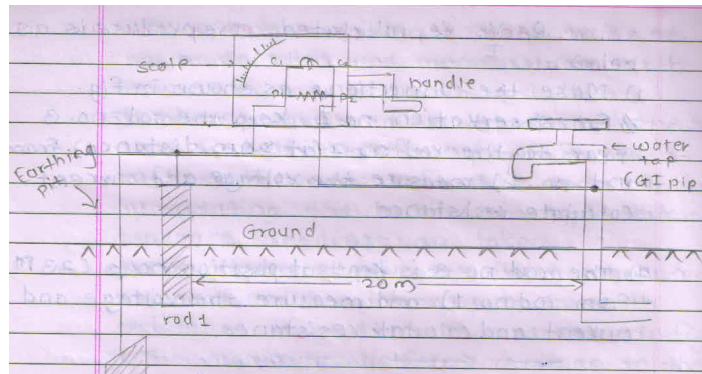

or equivalent figure

Earth resistance measurement test by water tap method is shown in figure.

As per this figure the water tap should be of GI pipe which is embedded in the ground.

The rod no.1 is not essential. **The procedure is as below.**

- Make the connections as shown in figure
- The common link of C1-P1 is connected to the earthing pit and common link of C2-P2 is connected to the water tap.
- The distance between the water tap to earthing pit should be near to 20m.
- By rotating handle of earth tester at near about 100 to 120 rpm measure the earth resistance on that earth tester.
- That resistance is declared as earth resistance of that earthing pit. In this test the accuracy is less but electrical rods are not required.

Q.5	Attempt any TWO of the following :	12 Marks
(a)	State Magnetostriction. Draw Hysteresis loop for : (i) High silicon steel (ii) Copper (iii) Soft iron (iv) Wood	
Ans:	Magnetostriction: It is the change in dimensions of ferro magnetic material when it is magnetized for eg. Silicon steel, iron or any ferromagnetic material.	(1 Mark)



i) Hysteresis loop for High silicon steel :

(2 Mark)

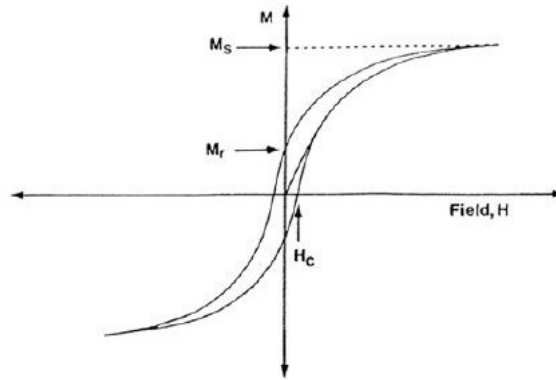

or equivalent figure

iii) Hysteresis loop for Soft iron :

(2 Mark)

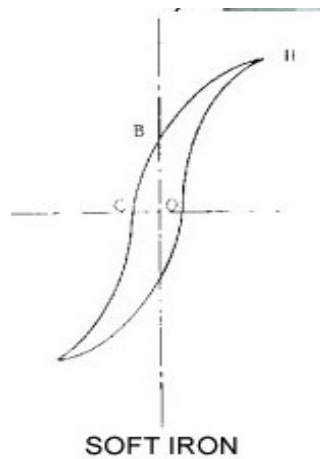

or equivalent figure

iv) Hysteresis loop for Copper and Wood :

(1 Mark)

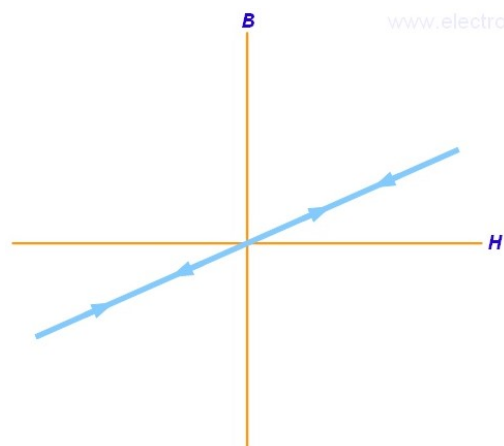

or equivalent figure



b)	State failure phenomena observed in insulating material. State four reasons for failure of gaseous and solid dielectric materials.
Ans:	Failure phenomena in insulating material means the dielectric property fails : (2 Marks) <p>The dielectric failure mean the dielectric strength of insulating material reduces due to high voltages or high temperature observed in insulating material and therefore decreases insulation resistance .</p> Reasons for failure of gaseous and solid dielectric materials: (4 Marks) <ol style="list-style-type: none">1. If the system voltage increases more than breakdown voltage for some interval then there are chances of dielectric failure2. Long time partial discharge in solid insulator will create dielectric failure.3. Due to super heating of dielectric material i.e. due to heavy load or over load temperature increases and dielectric failure occurs.4. Due to lighting surge there may be possibility of dielectric failure.5. Due to short circuit or ground fault there may be possibility of dielectric failure.6. Due to poor maintenance of insulating material there may be possibility dielectric failure
c)	State significance of earthing. Draw and explain pipe earthing. State the values of earth resistances for : (i) Substation (ii) Residential wiring (iii) H.T. Line (iv) L.T. Line
Ans:	Significance of earthing: (1 Mark) <ul style="list-style-type: none">➤ Earthing means connecting the body of the electrical equipment (it means the part which does not carries current under normal condition) to the earth. For example electrical equipment's frames, enclosures, supports etc.➤ The purpose of earthing is to minimize risk of receiving an electric shock if touching metal parts when a leakage current is present. Earthing has been done through bonding of a metallic system to earth with the help of wire. It is normally achieved by inserting ground rods or other electrodes deep inside earth.➤ Earthing is to ensure safety or Protection of electrical equipment and Human by discharging the electrical leakage current to the earth.➤ Generally Green wire is used for this as a nomenclature.



Pipe earthing :

(3 Mark)

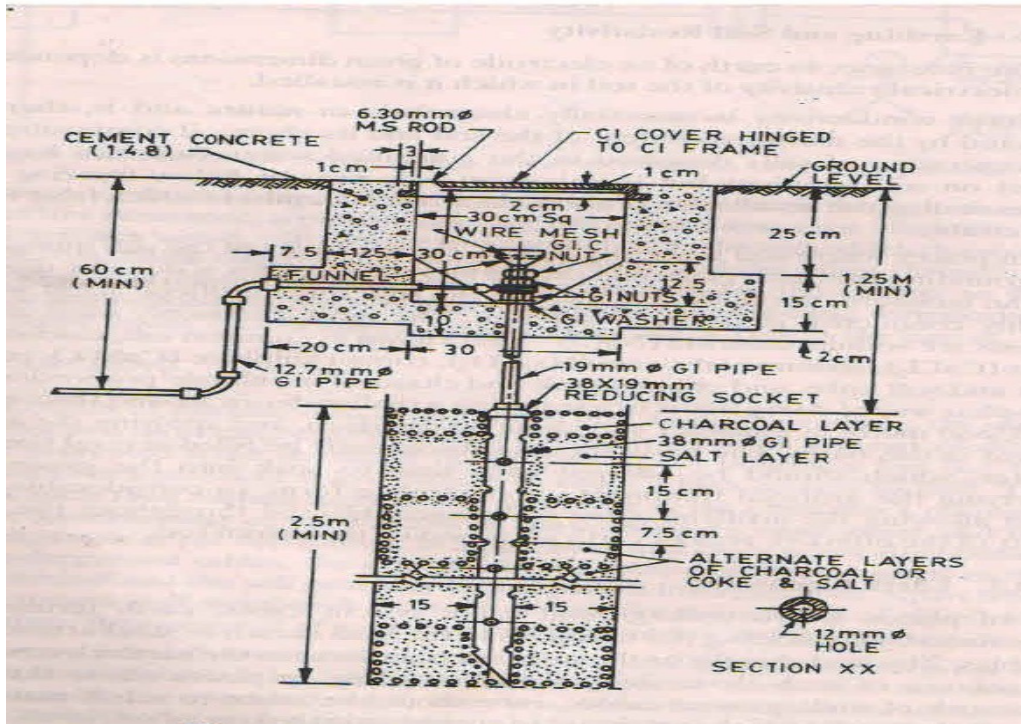

or equivalent

figure

Pipe earthing –

This type of earthing is used in rocky area where excavation is not possible for copper plate earthing.

The pipe used is generally of 38 mm diameter 2.5m long. The total depth of earthing is about 3.75m. surrounded by charcoal and salt.

the values of earth resistances for:

(2 Mark)

S.No.	Particulars	values of earth resistances
1	Substation	0.5 to 1.5 ohm
2	Residential wiring	5 ohm to 8 ohm
3	H.T. Line	1 ohm to 2 ohm
4	L.T. Line	2 to 3 ohm



MAHARASHTRA STATE BOARD OF TECHNICAL EDUCATION
(Autonomous)
(ISO/IEC-27001-2005 Certified)

WINTER- 2018 Examinations

Subject Code: 22328

Model Answer

Page 21 of 23

Q.6	Attempt any TWO of the following :				12 Marks
a)	Compare the electrical, mechanical and thermal properties of : i) asbestos (ii) mica (iii) porcelain as an insulating material				
Ans:	(Electrical Properties : 2 Marks, Mechanical Properties : 2 Marks & Thermal Properties: 2 Marks: Total 6 Marks)				
	S.No	Properties	Asbestos	Mica	Porcelain
		Electrical	Dielectric Constant 10-75	Dielectric Constant 4-7.5	Dielectric Constant 5-7
			Dielectric Strength 4-14 kV/mm	Dielectric Strength 10-18 kV/mm	Dielectric Strength 15 kV/mm
			Resistivity : 10^{10} - 10^{12}	Resistivity : 10^{12} - 10^{14}	Resistivity : 10^{13} ohm-cm at room temperature to about 10^{14} ohm-cm at 1200°C
			Used for low voltage	Used for high voltage	Used for high voltage
		Mechanical	Tensile strength : 0.24 - $0.64 \text{ kg/cm}^2 \times 10^{-3}$	Tensile strength : 0.35 - $0.5 \text{ kg/cm}^2 \times 10^{-3}$	Tensile strength : 200 - 400 kg/cm^2
			Compressive strength : 1 — $2.5 \text{ kg/cm}^2 \times 10^{-3}$	Compressive strength : 1 — $1.75 \text{ kg/cm}^2 \times 10^{-3}$	Compressive strength: 3000 kg. per cm^2
			Water absorption: 0.1 – 0.5 %	Water absorption: 0.01 – 0.1 %	Water absorption: 0.5 %
		Thermal	Temperature withstand capacity upto 400°C	Temperature withstand capacity upto 500-600°C	Temperature withstand capacity upto 1000°C
b)	Classify wiring. State the type of wiring installation used for following applications with justification : (i) Hospital (ii) Spinning mill (iii) Milk Dairy (iv) Hotel				
Ans:	Classification of Wiring –				(2 Marks)
	<ol style="list-style-type: none"> 1) Cleat wiring 2) Batten wiring 3) Wooden casing capping wiring 4) PVC conduit wiring 				



- 5) PVC casing capping wiring
- 6) Concealed wiring

Following wiring installation used for following applications with justification : (4 Marks)

S.No.	Application	Types of Wiring Installation	Justification
1	Hospital	1. Concealed Wiring, 2. PVC conduit wiring 3. PVC Casing Capping	1. Due to good appearance 2. Due to economy, repair & maintenance is simple 3. Due to easy expansion and fault finding simplicity.
2	Spinning Mill	1. PVC Conduit Wiring 2. PVC Casing Capping	1. Due to economy, repair & maintenance is simple. 2. Due to easy expansion and fault finding simplicity
3	Milk Dairy	1. Concealed Wiring 2. PVC Casing Capping	1. Due to good appearance 2. Due to easy expansion and fault finding simplicity
4	Hotel	1. Concealed Wiring, 2. PVC conduit wiring 3. PVC Casing Capping	1. Due to good appearance 2. Due to economy, repair & maintenance is simple 3. Due to easy expansion and fault finding simplicity.

c) Give the justification with diagram — "Earthing saves human life during Electrical faults". State adverse effect of improper earthing system.

Ans:

Diagram:

(2 Marks)

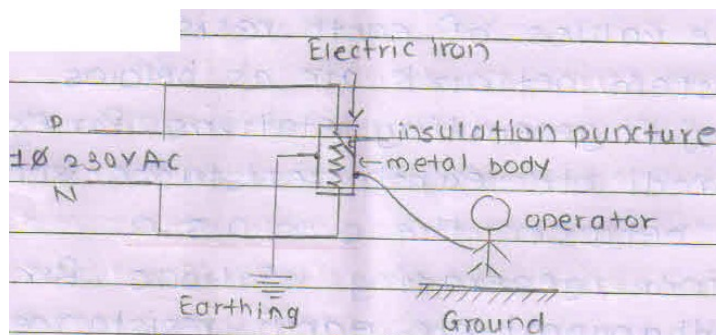

or equivalent figure



Justification of "Earthing saves human life during Electrical faults": (2 Marks)

- As per the above figure if earthing not done to the electrical equipment, at the time of insulation puncher (Means ground fault) the operator can get electrical shock.

To avoid this :

- If the metal body is connected to the earth then the earthing resistance is very less as compare to human body resistance and hence at the time ground fault all leakage current passes through the earth pit and the danger of electric shock to the operator is avoided.
- Thus we can conclude that by proper earthing human life is saved.

Adverse effect of improper earthing system: (2 Marks)

- There will be danger of electric shock to the human life.
- Danger of lightening stroke will be severe.
- Due to absence of earth wire there will be malfunctioning of relays and other switchgear operations.
- Poor service reliability
- Improper earthing may cause burns from arcing
- Tools plugged into improper earthing circuit may become energized.

-----END-----