

COURSE FILE

BUILDING MATERIAL CONSTRUCTION AND PLANNING

(Subject Code: A30107)

II YEAR B.TECH. (CIVIL ENGINEERING) II SEMESTER

Prepared by

MD .OSMAN GHANI

Asst. Professor



DEPARTMENT OF CIVIL ENGINEERING

GEETHANJALI COLLEGE OF ENGINEERING & TECHNOLOGY

CHEERYAL (V), KEESARA (M), R.R. DIST. - 501 301

(AFFILIATED TO JNTUH, APPROVED BY AICTE, NEW DELHI, ACCREDITED BY NBA)

www.geethanjaliinstitutions.com

2015 – 2016



GEETHANJALI COLLEGE OF ENGINEERING & TECHNOLOGY

CHEERYAL (V), KEESARA (M), R.R. DIST. 501 301

CONTENTS

- 1.1. Cover page
- 1.2. Syllabus
- 1.3. Vision of the department
- 1.4. Mission of the department
- 1.5. PEOs and POs
- 1.6. Course objectives and outcomes
- 1.7. Brief note on the importance of the course
- 1.8. Prerequisites
- 1.9. Instructional Learning outcomes.
- 2.0 Curriculum mapping with POs
- 2.1 Class Time Table
- 2.2 Individual Time Table
- 2.3 Lecture schedule with methodology being used
- 2.4 Detailed Notes
- 2.5 University Question Papers
- 2.6 Question Bank
- 2.7 Unit wise quiz questions
- 2.8 References, Websites and E links
- 2.9 Quality measurement sheet
- 2.9.1 Student List
- 3.9.2 Group wise student list for discussion topics

1.2 Syllabus:

UNIT – I

STONES, BRICKS AND TILES:

Properties of building stones – relation to their structural requirements. Classification of stones – Stone quarrying –precautions in blasting, Dressing of stone, Composition of good brick earth, various methods of manufacture of bricks. Comparison between clamp burning and kiln burning.

Qualities of a good brick. Characteristics of good tile – manufacturing methods, Types of tiles. Use of Materials like aluminium, gypsum, glass and bituminous materials – their quality.

UNIT-II

CEMENT AND ADMIXTURE:

Various ingredients of lime – Constituents of lime stone – classification of lime – various methods of manufacture of lime. Various types of cement and their properties. Various field and laboratory tests for Cement. Various ingredients of Cement concrete and their importance – various test for concrete.

UNIT – III

BUILDING COMPONENTS:

Lintels, Arches, Vaults-stair cases – Types. Different types of floors-Concrete, Mosaic, floors, Pitched, flat and curved Roofs. Lean-to- Roof, Coupled Roofs, Trussed roofs- King and Queen Post Trusses. RCC Roofs, Madras Terrace/Shell Roofs. WOOD: Structure – properties – Seasoning of timber. Classification various types of woods used in buildings – Defects in timber. Alternative materials for wood, Galvanized Iron, Fiber-reinforced plastics, steel, Aluminum

Proofing Damp and water proofing- materials used. Plastering, pointing, white washing and distempering –Painting – Constituents of a paint – Types of paints – Painting of new/old Wood – Varnish – Form work and scaffolding.

UNIT –IV

MASONRY AND FINISHING: Brick masonry Brick masonry Types and bonds Stone masonry Types Composite masonry Brick stone composite Concrete reinforced brick finishing plastering pointing painting cladding types tiles etc

Form work: Introduction Requirement Standard scaffolding,. Design under pinning shoring

UNIT – V

Building planning: Principal of building planning Classification of building, Building by laws

TEXT BOOKS:

1. Building material by S K Duggal – New Age International Publishers; Second Edition
2. Building Construction by B.C.Punmia, Ashok Kumar Jain and Arun Kumar Jain - Laxmi Publications (P) ltd., New Delhi
3. Building Construction by P.C. Varghese, Prentice-Hall of India private Ltd, New Delhi

REFERENCES:

1. R.Chudly “Construction Technology “– Volumes I and II” 2nd Edition, Longman, UK, 1987.
2. Building materials by P.C. Varghese, Prentice-Hall of India private Ltd, New Delhi.

1.3 Vision of the Department:

The Vision of the Department of Civil Engineering is to be a world class academic centre for quality education and research in diverse areas of Civil Engineering, with a strong social commitment.

1.4 Mission of the Department:

- Impart quality education in undergraduate and post graduate levels, with strong emphasis on professional ethics and social commitment
- Provide a scholastic environment for state – of –art research, resulting in practical applications
- Produce highly competent and technologically capable professionals and motivated young academicians;
- Undertake professional consultancy services in diverse areas of Civil Engineering;
- Conduct knowledge exchange programmes with various stakeholders.

1.5 PEOs and POs:

The Civil Engineering Department is dedicated to graduating Civil engineers who:

- Practice Civil engineering in the general stems of Design, Irrigation, Transportation & Highways , Water Distribution systems
- Apply their engineering knowledge, critical thinking and problem solving skills in professional engineering practice or in non-engineering fields, such as law, medicine or business.
- Continue their intellectual development, through, for example, graduate education or professional development courses.
- Pursue advanced education, research and development, and other creative efforts in science and technology.
- Conduct them in a responsible, professional and ethical manner.
- Participate as leaders in activities that support service to and economic development of the region, state and nation.

1.6 Course objectives and Outcomes:

- Different type of material
- Standards specification of material
- Manufacturing of building material
- Transport of material .

1.7 Brief note on the importance of the course:

COURSE DESCRIPTION:

The course covers the following topics; stones and bricks ,building stones. classification and quarrying properties, manufacture and structural requirement wood structure types and properties , ingredient of cement ,manufacturing chemical composition ,building components, building services masonry and finishes form work building planning

Introduction to the subject

Building material is any material which is used for construction purposes. Many naturally occurring substances, such as clay, rocks, sand, and wood, even twigs and leaves, have been used to construct buildings. Apart from naturally occurring materials, many man-made products are in use, some more and some less synthetic. The manufacture of building materials is an established industry in many countries and the use of these materials is typically segmented into specific specialty trades, such as carpentry, insulation,, plumbing, and roofing work. They provide the make-up of habitats and structures including homes. In history there are trends in building materials from being: natural to becoming more man-made and composite; biodegradable to imperishable; indigenous (local) to being transported globally; repairable to disposable; and chosen for increased levels of fire-safety. These trends tend to increase the *initial* and *long term* economic, ecological, energy, and social costs of building materials.. Clay based buildings usually come in two distinct types. One being when the walls are made directly with the mud mixture, and the other being walls built by stacking air-dried building blocks called mud bricks. Other uses of clay in building is combined with straws to create light clay, wattle and daub, and mud plaster. Rock structures have existed for as long as history can recall. It is the longest lasting building material available, and is usually readily available. There are many types of rock throughout the world, all with differing attributes that make them better or worse for particular uses. Rock is a very dense material so it gives a lot of protection too; its main drawback as a material is its weight and awkwardness. Its energy density is also considered a big drawback, as stone is hard to keep warm without using large amounts of heating resources. Dry-stone walls have been built for as long as humans have put one stone on top of another. Eventually, different forms of mortar were used to hold the stones together, cement being the most commonplace now. The granite-strewn uplands of Dartmoor National Park, United Kingdom, for example, provided ample resources for early settlers. Circular huts were constructed from loose granite rocks throughout the Neolithic and early Bronze Age, and the remains of an estimated 5,000 can still be seen today. Granite continued to be used throughout the Medieval period (see Dart moor longhouse) and into modern times. Slate is another stone type, commonly used as roofing material in the United Kingdom and other parts of the world where it is found. Stone buildings can be seen in most major cities; some civilizations built entirely with stone such as the Egyptian and Aztec pyramids and the structures of the Inca civilization

1.8. Pre-requisites:

- Different type of material
- Standards specification of material
- Manufacturing of building material
- Transport of material

1.9 Instructional Learning outcomes

- 1) Types of building and components of building
- 2) To understand different material using for construction
- 2) Design load and specification of material
- 3) Classification of quarrying building
- 4) Types of properties of wood aluminum paint;
- 5) To know about building services
- 6) Masonry finishing plastering painting
- 7) Standards of building material
- 8) Principal of building planning and by laws

2.0 Curriculum mapping with Pos:

Curriculum mapping is a method to align instruction with desired goals and program outcomes. It can also be used to explore what is taught and how. The map:

- Documents what is taught and when
- Reveals gaps in the curriculum
- Helps design an assessment plan

Benefits:

- Improves communication about curriculum among faculty
- Improves program coherence
- Increases the likelihood that students achieve program-level outcomes
- Encourages reflective practice

2.1 Class Time Table:

DEPARTMENT OF CIVIL ENGINEERING

Year/Sem/ II B.Tech II -Sem CE-B

ROOM NO :

Acad. Yr : 2015-16

WEF: 2/12/15

CLASS INCHARGE: _____

DAY	9.30-10.20	10.20-11.10	11.10-12.00	12:00-12:50	L U N C H	2.20-3.10	3.10-4.00	4:00-4:30
Period	1	2	3	4		5	6	7
MON	LAB			EVS		BMC	HHM	
TUE	LAB			P&S		S.A		BMC
WED	S.A	EVS	HHM			BMC		
THU	B.M.C		HHM	S.A		P&S	EVS	LIBRARY
FRI	P&S	SOM	CRT			SOM		MENTORING
SAT	SOM	P&S	EVS	HHM		SEMINAR		P&S

2.2 Individual Time Table

Name of the faculty: MD OSMAN GHANI .

Load = 18

; w.e.f.: 2/12/15

DAY	9.30-10.20	10.20-11.10	11.10-12.00	12:00-12:50		2.20-3.10	3.10-4.00	4:00-4:30
Period	1	2	3	4	L	5	6	7
MON	LAB				L U N C H	BMC		
TUE	LAB							BMC
WED						BMC		
THU	B.M.C							
FRI	LAB							
SAT		LAB						

2.3 Lecture schedule with methodology being used:

Sl No	Unit No.	Total No. of Periods	Topics to be covered	Reg./ Additional	Teaching aids used LCD. OHP.BB	Remarks
1	I	8	STONES AND BRICKS,TILES Introduction	Regular	LEDP, OHP,BB	
2			Building stones	Regular	LEDP, OHP,BB	
3			Classification quarrying properties	Regular	LEDP, OHP,BB	
4			Structure requirement	Regular	LEDP, OHP,BB	
5			Dressing bricks,Compositing of brick earth, manufacture and structural requirement	Regular	LEDP, OHP,BB	
6			Wood aluminum glass and paints Wood structure types and properties seasoning defects	Regular	LEDP, OHP,BB	
7			Alternate material for wood gi/fiber reforced glass bricks steel aluminium	Regular	LEDP, OHP,BB	
8			Tutorial class-1			
9	II	7	CEMENT AND ADMIXTURE:	Regular	LEDP, OHP,BB	
10			Ingredient of cement	Regular	LEDP, OHP,BB	
11			manufacture chemical composition hydration	Regular	LEDP, OHP,BB	
12			field and lab test admixture	Regular	LEDP, OHP,BB	
13			mineral and chemical admixture	Regular	LEDP, OHP,BB	
14			uses	Regular	LEDP, OHP,BB	
15			Tutorial Class-2,3	Regular		
			Solving University papers			
	Assignment test-1					
21						
22	III	8	BUILDING COMPONENTS :: Lintels, Arches, Vaults-stair cases	Regular	LEDP, OHP,BB	
23			Types. Different types of floors-Concrete, Mosaic,Terrazo floors, Pitched, flat and curved Roofs Trussed	Regular	LEDP, OHP,BB	
24			Foundation types , Proofing Damp and water proofing dooe window material types	Regular	LEDP, OHP,BB	
25			BUILDING SERVICES: plumbing services water distribution sanitary lines and fittings	Regular	LEDP, OHP,BB	
26			Ventilation function required system of ventilation air condition essectial and types	Regular	LEDP, OHP,BB	

27			Acoustic characteristics obserbtion Acoustic design	Regular	LEDP, OHP, BB			
28			Fire protection fire hazard classification fire resistant material and construction	Regular				
30			Solving University papers					
31			Assignment test-2, Tutorial Class-4					
32	IV	18	Masonry and finishing's Introduction	Regular	LEDP, OHP, BB			
33			Brick masonry	Regular	LEDP, OHP, BB			
34			Types and bonds	Regular	LEDP, OHP, BB			
35			Stone masonry	Regular	LEDP, OHP, BB			
36			Types	Regular	LEDP, OHP, BB			
37			Composite masonry	Regular	LEDP, OHP, BB			
38			Brick stone composite	Regular	LEDP, OHP, BB			
39			Concrete reinforced brick finishing plastering pointing painting cladding types tiles acp	Regular	LEDP, OHP, BB			
40			Form work: Introduction	Regular	LEDP, OHP, BB			
41			Requirement	Regular	LEDP, OHP, BB			
42			Standard scaffolding,.	Regular	LEDP, OHP, BB			
43			Design under pinning shoring	Regular	LEDP, OHP, BB			
44			Tutorial Class-5	Regular				
45			Solving University papers					
46			Assignment test-3					
47			V	18	Building planning	Regular	LEDP, OHP, BB	
48					Principal of building planning	Regular	LEDP, OHP, BB	
49					Principal of building planning	Regular	LEDP, OHP, BB	
50	Classification of building	Regular			LEDP, OHP, BB			
51	Classification of building	Regular			LEDP, OHP, BB			
52	Classification of building	Regular			LEDP, OHP, BB			
53	Building by laws	Regular			LEDP, OHP, BB			
54	Building by laws	Regular			LEDP, OHP, BB			
55	Assignment test-4	Regular			LEDP, BB			
56	Assignment test-5	Regular			LEDP, BB			

57		Revise	Regular	LEDP, OHP, BB	
58		Revise	Regular	LEDP, OHP, BB	
59		Revise	Regular	LEDP, OHP, BB	
60		Revise		LEDP, OHP, BB	
61		Revise	Regular	LEDP, OHP, BB	
62		Tutorial Class-6			
64		Solving University papers	Regular	VOHP, B B	
65		Assignment test-6	Regular	LEDP, BB	

2.4 Detailed Notes:

MD OSMAN GHANI, ASSISTANT PROFESSOR, GEETANJALI INSTITUTE OF ENGG & TECH, keesara.

Mob: 8801681201

, GEETANJALI INSTITUTE OF ENGG & TECH, keesara.

Notes on Building Materials , Construction and Planning
for B.Tech (civil) – II year students

.....**compiled by MD OSMAN GHANI M.TECH**

UNIT- I: STONES AND BRICKS, TILES:

Contents

Introduction of Building Stones
Igneous Rocks... Plutonic igneous rocks
Volcanic igneous rocks
Hypabyssal igneous rocks
Table of Igneous rocks
Sedimentary Rocks
Metamorphic Rocks
Quarrying of Stones Selection of a site for quarrying
Stone quarrying tools
Methods of quarrying
Blasting Materials for blasting
Precautions in blasting
Storage of explosives
Quantity of explosives required
Properties of Building stones
Dressing of a stone
Artificial stones
Forms of Artificial stones
BRICKS characteristics of good brick
Composition / Ingredients of good brick earth
Harmful substances in brick earth
Manufacturing of bricks
Kilns Bull's Trench Kilns

Intermittent Kilns
Continuous Kilns
Tests for bricks
Different forms of bricks

Contents:

Trees Exogenous
..... Endogenous
..... Uses
Classification of Timber / wood
On the basis of its position
On the basis of Grading
On the basis of Modulus Elasticity
On the basis of availability
On the basis of durability
On the basis of treatability
Structure of a tree Macro structure
.... Micro structure
Seasoning of timber
Methods of seasoning ... Natural seasoning
Artificial seasoning
Defects in Timber / Defects due to seasoning
Glass Introduction
Manufacture of glass
Classification of glasses & uses .
Paints Introduction
Composition of oil pain
Types of paints

BUILDING STONES: Man requires different types of buildings such as houses, bungalows, flats etc for his living. For his activities man also require Hospitals for his health; Schools, Colleges and Universities for his education; Banks, Shops, Offices and Factories for doing works; Railway buildings, Bus stations and Air terminals for his transportation; Clubs and Theatres for recreation and Temples, Mosques, Churches etc for worship.

Each type of the above buildings has its own requirements and needs building stones to construct the same. The period from 1750 A D onwards is known as the period of *Modern Architecture*.

The use of reinforced concrete in construction triggered the rapid development of modern architecture. Structural components such as Columns, RCC slabs became increasingly popular because of the increased speed in construction.

Use of plywood; glass, decorative materials etc helped the designers to make the new structures look more elegant in addition to the usage of various building stones.

So, the engineering structures are composed of materials and are known as the *engineering materials (or) building materials*. Hence, Building materials have an important role to play in this modern age of technology

Building stones are obtained from rocks, are derived into three groups viz., *Igneous, Sedimentary and Metamorphic rocks*.

IGNEOUS ROCKS are the first formed rocks in the earth's crust and hence these are called PRIMARY ROCKS, even though igneous rocks have formed subsequently also.

Igneous rocks are the most abundant rocks in the earth crust and are formed at a very high temperature directly as a result of solidification of magma since magma is the parent material of igneous rocks.

The temperature increases proportionately with the depth -- this is one of the reasons for the formation of igneous rocks. Eg: Granite, Syenite, Dunite, Gabbro, Basalt.

Igneous rocks are usually massive, unstratified, unfossiliferous and often occur as intrusive cutting across other rocks (country rocks or host rocks) and the chemical composition of a rock is expressed in terms of oxides for eg: SiO_2 ; Al_2O_3 ; Fe_2O_3 ; FeO ; MgO ; CaO ; TiO_2 etc

The igneous rocks are classified based on silica%, silica saturation and depth of formation

1. CLASSIFICATION BASED ON SILICA % :

Nature	Silica	% Rock examples
Acidic \geq	65	Granite, Pegmatites; (coarse) ; Rhyolite (fine)
Intermediate	55 – 65	Syenite (coarse) ; Trachyte (fine)
Basic)	45 – 55	Gabbro (coarse) ; Basalt (fine
Ultrabasic <	< 45	Picrite, Peridotite , Dunite (coarse)

2. CLASSIFICATION BASED ON SILICA SATURATION: Depending on the silica content in parent magma; the igneous rocks are categorized as:

Oversaturated igneous rocks: when the parent magma is rich in silica, saturated minerals like feldspars are formed and the surplus quantity of silica crystallizes as quartz. Other (unsaturated) minerals like olivine, nepheline, leucite never occur in over saturated igneous rocks. Eg: Granites, Granodiorites, Rhyolites, Dacite.

Saturated igneous rocks: When the parent magma has enough silica, the resulting rocks possess neither quartz nor any unsaturated minerals (olivine; nepheline; leucite). Presence of feldspars are seen in saturated igneous rocks. Eg: Syenite, Diorite ; Anorthosite, Gabbro ; Trachyte; Andesite; Basalt; Dolerite.

Unsaturated igneous rocks : These rocks are composed of both saturated minerals and unsaturated minerals when the parent magma has silica less than what is required. . Quartz is possible to the extent and feldspars, olivine, nepheline, leucite etc are present.

When the parent magma is highly deficient in silica, quartz may not be formed at all. This group also represents under saturated rocks such as Dunites, Peridotites, Nepheline Syenite; Phonolite; Limburgite etc.. Comparison of silica saturation classification with that of silica percentage classification shows that they are inter-related.

CLASSIFICATION BASED ON DEPTH OF FORMATION:

Igneous rocks are grouped into Plutonic rocks; Hypabyssal rocks and Volcanic rocks based on their depth of formation.

PLUTONIC ROCKS: The igneous rocks which have formed under high temp & pressure at greater depths in the presence of volatiles in the earth's crust are called plutonic rocks.

High pressure ensure total crystallization of minerals formed and the hot surroundings slow down the process of solidification. Hence, slow cooling and crystallization of magma slower the process of solidification and the net result of all these processes is the development of coarse grained texture. Eg: Granite ; Granodiorite, Syenite; Diorite, Anorthosite, Nepheline Syenite.

VOLCANIC ROCKS: The igneous rocks which have formed under low temp & pressure at shallow depths in the absence of volatiles in the earth' crust are called volcanic rocks. Rapid cooling and quick crystallization of lava makes faster the process of solidification due to heat difference. The net result of all these processes is the development of fine grained texture. Eg: Rhyolite; Dacite; Trachyte; Andesite; Basalt; Phonolite; Obsidian; Trachylite; Limburgite.

HYPABYSSAL ROCKS: The igneous rocks which have formed under moderate temp & pressure at shallow depths are called hypabyssal rocks. Medium rate of cooling causes for the formation of medium grained rocks. Eg: Dolerite; Tinguite
From the observations, it is understand that the oversaturated rocks are equivalent to acidic igneous rocks. Saturated rocks are equivalent to intermediate igneous rocks. Under saturated rocks are roughly equivalent to basic / Ultrabasic rocks

Among the rocks, granite is the chief building stone because of its hard nature, durability etc.. However, granite is unsuitable for carving work. By virtue of many desirable qualities, granite can be used in foundations of civil structures, building stone, road metal. Granite is more suitable for heavy engineering works such as dams, bridges, piers etc...

Volatiles: When elements and compounds are dissolved in a silicate melt it is known as volatile. . Common volatiles are S; N; Cl; F; B; Fe; H₂O; CO₂; HCl; HF; SO₂; SO₃; H₂S; NH₄.

GRANITE: Among different rocks, Granite (a plutonic rock) is one of the most abundant rock formed due to solidification of magma at greater depths. It is a holocrystalline (completely crystalline) and leucocratic (light coloured) rock .

Composition: Granite consists of quartz (> 20 – 30 %), Feldspars (60%) include alkali feldspars (orthoclase microcline) and plagioclase feldspars (oligoclase) , micas as essential minerals and accessory minerals are mafic minerals such as hornblende, biotite / muscovite , pyroxenes of hypersthene; augite ; diopside ; magnetite / haematite, rutile, zircon, apatite, garnet.. Granite is compact, massive and hard rock. Granites are unstratified but characterized by joints.

Texture: Granites exhibit an interlocking texture, Phaneric texture, coarse grained texture, graphic texture (similar to Arabic writing) . Granites are usually equigranular but some times show inequigranular texture in case of Porphyritic texture (feldspars occur as phenocrysts) .

Hand specimen: Granite is generally medium to coarse grained and grayish or pinkish in color. Feldspar appears with white or brownish – red color. Quartz looks colorless. Biotite is jet black and is found as small shining flakes. Hornblende is dark greenish black.

Varieties: GRANODIORITE; DIORITE ; ADAMELLITE; CHARNOCKITE; PEGMATITE; RHYOLITE

When the accessory minerals present more in quantity than normally such rocks are named as eg; **biotite granite, hornblende granite**. Based on the color of feldspars, the granites are termed as Pink granite; grey granite.

Granitic rocks occur in the form of large igneous bodies such as batholiths, stocks and bosses.

SPECIAL FEATURES: Specific gravity of granite is 2.6 – 2.8
Density = 2500 – 2650 kg/cm³; compressive strength = 1000 – 2500 kg /sq cm

ENGINEERING POINT OF VIEW: By virtue of many desirable qualities, granite can be used in foundations of civil structures, building stone, road metal,. Tunneling through granite does not require any lining.

SEDIMENTARY ROCKS are those formed due to weathering and / or erosion of the pre-existing rocks. Also formed due to chemical precipitation or due to accumulation of organic remains such as plants and animal hard parts. In other words, most of these rocks have been derived from breaking up of igneous rocks whose particles are conveyed and deposited by streams or rivers and accumulated to form thick strata that have been subsequently hardened by pressure.

The principal building stones in this group are limestones and sandstones. These are used in floors, steps, walls etc.. Other rocks such as Arkose, Grey wackes, Laterites; Conglomerates; Breccia; Mudstones, Siltstones are also belonging to sedimentary rocks but has less importance for civil works.

METAMORPHIC ROCKS are those formed due to metamorphic agents such as heat or pressure or both when acted on either igneous or sedimentary rocks
The common building stones that fall under this category are Slates, Marbles, Quartzites, Phyllites, Gneisses etc..
As a result of metamorphism:

Granite changes to Gneiss
Sandstone changes to Quartzite
Limestone changes into Marble
Shale changes into Phyllites / Slates.

Among the metamorphic rocks, Gneisses and Quartzites are used for flooring, steps, as building stone, road metal, railway ballast. Marbles are chosen for face works, wall panels, statue making etc..

GNEISS: A name is generally given to any metamorphic rock when shows a gneissose structure. A few details of its physical description are as follows:

Diagnostic character: Foliation present.

Color: grey and pink but generally pale coloured

Grain size: medium to coarse grained

Texture and Structure: Generally equigranular but sometimes orphyroblastic.

Foliation is also seen. The minerals occur as alternating white and black colour bands.

Minerals present: Feldspars and quartz usually make up the bulk of a gneiss. In addition, garnet, rarely pyroxenes occur in such bands.. If hornblende and biotite are present, then the rock appear as dark or black coloured bands. The other minerals which may also occasionally occur in gneisses are chlorite, sillimanite, kyanite, staurolite, talc, serpentine etc..

Types: Based on texture, mineral content etc different varieties of gneisses are named.

Orthogneiss: This is a gneiss derived from igneous rock

Paragneiss: This is a gneiss derived from sedimentary rock

Granitic gneiss: if a gneiss, which has minerals similar to that of granite.

Banded gneiss: A variety of gneiss in which alternating wide colour bands.

Augen gneiss: This is a gneiss in which quartz and feldspars appear as thick elongated lens shaped (resemble to eye).

Origin: Gneisses are usually formed out of Dynamothermal metamorphism of granites, Syenites, sandstones, conglomerates.

Properties and uses of civil engineering importance:

It is a silica – rich rock and is durable.

Due to non-porous and impermeable, it has good strength.

The foliation to some extent, improves the workability of gneiss.

It may be used as building stone in addition to road metal, as railway ballast, as load bearing beams.

In case of tunneling, the presence gneiss doesn't require any lining.

QUARRYING OF STONES: The process of taking out stones from exposed surface of natural rock beds is known as the quarrying. While selecting a quarry site, one should remember that the availability of quantity; desired quality, transportation facilities, cheap local labour, and free from the permanent structures in the vicinity , drainage of rainwater etc..

In case of a quarry, the operations are carried out at ground level (in an exposed condition) whereas in case of mine, the operations are carried out under the ground at greater depths.

SELECTION OF A SITE FOR QUARRYING:

- Availability of Raw material, Tools, Power, Labour
- Space for dumping of refuse material.
- Distance of quarry from roads, railways..
- Proximity to the transportation facilities.
- Easy availability of clean water in sufficient quantity throughout the year

- Economy in quarrying
- Blasting material availability
- Absence of permanent structures
- Geological data regarding rock formations.

STONE QUARRYING TOOLS: Some of the quarrying tools such as Dipper; Priming needle; Scrapping spoon; Tamping bar; Wedge; Steel Pin; Jumper, Crowbar, are used in quarrying.

Dipper is used to drill a hole to the required depth.

Priming needle : After filling the hole with explosive, the hole is filled with earth material and this needle is kept in the centre so that its removal will develop a passage for the insertion of fuse to cause explosion.

Scrapping spoon is used to remove dust of crushed stone from blast holes. It is in the form of an iron rod with a circular plate attached to one end and provided with a loop at the other end.

Tamping bar is used to tamp the material while refilling the blasting holes. It is in the form of a heavy brass rod of 10 – 15 mm in dia and tappers a little at the ends.

Wedge: If rock surfaces contains rocks or fissures, these are driven by using Wedges / Pins through the hammers. Plug or feather are also used.

METHODS OF QUARRYING: The purpose of quarrying is to obtain building stones for various engineering purposes. A knowledge of various quarrying methods is essential.

Depending upon the nature of rocks and the purpose for which stones are needed, quarrying is done by adopting the following methods:

Quarrying by employing Hand tools for digging / excavation

Heating and

Wedging

1. *Digging / excavation:* In this method, the stones are merely excavated with the help of suitable hand tools such as Pick axes, Hammers, Spades, Chisels. This method is useful when soft stones occur in the form of large / small blocks.

2. *Heating:* In this method, the surface of rock is heated by placing pieces of wood or by piling a heap of fuel over the surface and fired for a few hours. Due to unequal expansion, the upper layer of rock separates out. The detached portion of rock is then removed by suitable hand tools.

This method is suitable when the rock formation consists of horizontal layers of shallow depth. Sometimes, intermediate layers are to be separated from the top and bottom layers. In such a case, the intermediate layer is heated and the expansion separates it from the other two.

3. *Wedging:* This method of quarrying is usually adopted for stratified rocks such as Sandstone, Limestone, Marble, Slate, Laterite etc.. About 10 – 15 cm deep holes, at around 10 cm spacing are made vertically in the rock. Steel Pins and Wedges or Plugs are inserted in them. These plugs are then struck simultaneously with sledge hammer. The rock slab splits along the lines of least resistance through the holes.

A plug is a conical steel wedge while a feather is a flat steel wedge with its upper end slightly curved.

Blasting: In this method, the explosives are used to convert rocks into small pieces of stones. The main purpose of quarrying stones by blasting is to loosen large masses of rocks. Explosives such as Blasting powder, Dynamite, Gelatin, Detonators, Fuse coil etc.. are used. This method is adopted for quarrying hard stones, having no fissures or cracks.

Materials for blasting:

Detonators: It is in the form of a copper cylinder having 6 mm dia and length 25 mm. It is closed at one end with projecting fuse at other end. It is partly filled with 6 to 9 grains of fulminate of mercury. It is used when dynamite is adopted as explosive. The detonators are fired either by fuse or electric spark.

Explosives: The blasting powder and dynamite are commonly used as the explosives. The blasting powder is also known as the Gun Powder which is a mixture of charcoal, salt petre (KNO_3) and sulphur. Sometimes, the salt petre is substituted by chile salt petre ($NaNO_3$).

Dynamites: It consists of 25% of sandy earth saturated with 75% of nitro-glycerin and this percentage composition varies with the nature of work. It is in the form of thick paste and is very poisonous in nature.

COMPARISION OF BLASTING POWDER AND DYNAMITE

Item	Blasting Powder	Dynamite
Cost	Cheap	High cost and is about 5 times than that of blasting powder
Destructive power	weak	Very strong and 6 times than that of blasting powder.
Efficiency	0.40 m ³ (normal in case of 1N powder is used)	0.60 m ³ (1 1/2 times than blasting powder if 1N powder is used) (1 1/2 times than
Use	Used for ordinary type of	Used for tunneling and

	quarrying work	mining operations
--	----------------	-------------------

Fuses: It is required to ignite the explosives. It is in the form of a small rope of cotton coated with tar and with a core of continuous thread of fine gun powder. The rate of burning of a good fuse is about 10 mm per second.

Gelignite: It consists of 65% blasting gelatin and 35% of absorbing powder. It is more convenient than dynamite. It is a powerful explosive and can be used under water.

Gun cotton: The clean cotton is saturated in a cool mixture of nitric acid and sulphuric acid. It is pressed into blocks or sticks while it is wet. It is as strong as dynamite. But its shattering power is less.

Blasting gelatin: It consists of 93% of Nitro-glycerin and 7% of gun cotton. It is a jelly – like mass. It has high explosive power of about 50% more than that of dynamite.

Liquid Oxygen: It is oxygen in liquid state. It is stored in a special container. It is comparatively cheap and used and used for blasting on a large scale for mining operations.

PRECAUTIONS IN BLASTING:

- Blasting should not be carried out in late evening or early morning hours
- A siren should warn the work men and nearby public to maintain a safe distance.
- The danger zone, an area of about 200 mts radius should be marked with red flags.
- First aid should be available
- The number of charges exploded and the misfires should be recorded
- Explosives should be stored and handled carefully.
- Detonators and explosives should not be kept together

STORAGE OF EXPLOSIVES:

- The explosives should be stored in a magazine which should be away from residential areas, petrol depots.
- The magazine should have ventilators at high levels and should have concealed wiring.
- Magazine should be protected from lightning.
- Smoke or fire should not be allowed in the nearby area.
- Explosives should be protected from extreme heat or cold and also from moisture.
- The magazine should be surrounded by a barbed wire and the entry should be restricted.

QUANTITY OF EXPLOSIVES REQUIRED: The quantity of explosives required depends upon several factors such as strength of explosive, method of blasting, number of bore holes --- their size, position etc and the type and mass of rock to be dislodged.

A rough estimate can be made by $A = L^2 / 0.008$ where

A = quantity of gun powder or dynamite (gm)

L = Length of Line of Least Resistance (mts)

PROPERTIES OF BUILDING STONES: Various properties such as Porosity, Permeability, Crushing Strength, Appearance, Durability; Co-efficient of Hardness; Specific gravity; Texture; Toughness Index; Water Absorption; Weathering; Density; Bulk Density; Density Index; , Temperature Resistance etc., are to be properly studied before making final selection of any building material for a particular use.

Porosity (α): In simple terms, porosity may be described as the amount of openings (or) interstices (or) empty spaces present in a rock. However, Porosity may be defined as “the ratio of openings or pores or voids (V_i) in the soil/rock to the total volume of the soil / rock (V) expressed as percentage”. If α is the porosity, then $\alpha = V_i / V$ where V_i is the volume of interstices and V is the total volume. The average porosity values for some common geological formations are as follows:

Rock	Porosity	Rock	Porosity
Granite, Quartzite	1.5 %	Only Gravel	25 %
Shale, Slate	4 %	Only Sand	35 %
Limestone	5-10 %	Only Clay	45%
Sand with gravel	20-30%		

Permeability : The permeability of a rock or soil defines its ability to transmit a fluid or water . Permeability depends on the porosity and interconnected pores character of the rock, thus more porous rocks are more permeable too. (not always). Permeability in a rock is measured in *darcies* ($1 \text{ darcy} = 0.987 \mu m^2 .\text{square micrometer}$).

- Eg: 1. Shales are highly porous but less permeable because of fine grained nature which does not allow water to pass through the rock due to less interconnected pores.
- Eg: 2. Vesicular basalts are highly porous but less permeable because the vesicles in them are not interconnected (i.e., the effective porosity is less).

Crushing Strength: For a good stone, the crushing strength should be greater than 100 Newton's / mm² . The approximate value of crushing strength of some of the stones are:

S No	Rock	type Building Stone	C S (N/mm ²)
1	Igneous	Basalt	150 – 185
2		Diorite	90 – 150
3		Granite	75 – 127
4		Syenite	90 – 150
5	Sedimentary	Limestone	54
6		Sandstone	64
7		Shale	0.20 – 0.60
8	Metamorphic	Gneiss	206 – 370
9		Slate	75 - 207

Appearance: The stones which are to be used for face work should be decent in appearance and capable of preserving their color uniformly for a long time. It is desirable to prefer light colored stones as compared to dark coloured stones because there are chances of the latter variety to be attacked easily by weathering agents.

Durability: A good building stone should be durable. The various factors such as Chemical composition; Resistance to atmospheric conditions etc... influence the durability of a stone. Following are the important atmospheric agencies which affect the durability of a stone

- a) Alternate conditions of heat and cold due to differences in temperature
- b) Alternate conditions of wetness & dryness due to rain and sunshine
- c) Chemical agencies such as dissolved gases in rain (eg: NO_x; SO_x)
- d) Growth of trees and Creepers in the joints between the stones.
- e) Wind with high velocity.

Co-efficient of Hardness: The co-efficient of hardness, as worked out in hardness test should be greater than 17 for a stone to be used in road work. If it is between 14 and 17, and < 14, the stone is said to be medium and poor hardness respectively and such stone should not be used in road works.

Specific gravity: For a good building stone, the specific gravity should be greater than 2.7 The heavy varieties of stones with more compact and less porous can be used for various engineering applications such as dams, weirs, retaining walls, docks etc.. On the other hand, the lighter varieties of stones are to be used for domes, roof coverings etc..

Texture: A building stone should have compact, fine crystalline nature, free from cavities, cracks, loose material, softness etc..

Toughness Index: In impact test, if the value of toughness index comes below 13, the stone is not tough. If it comes between 13 and 19, the stone is said to be moderately tough. If it exceeds 19, the toughness of stone is said to be high.

Water Absorption denotes the ability of the stone / material to absorb and retain water. It is expressed as % in weight or of the volume of dry material.

$Ww = \frac{M1 - M}{M} \times 100$ where= M1 means mass of saturated material (g)

V M means mass of dry material (g)

V means volume of material including the pores (mm³)

A good stone, the absorption % by weight after 24 hours should not exceed 0.60. If rain water is absorbed by porous stones causing them to crumble hence, the porous stones are not to be recommended for places subjected to rain, moisture, frost...

Weathering: A building stone should be capable of with standing adverse effects of various atmospheric and external agencies such as rain, frost, wind etc..

Density (ρ) is the mass of a unit volume of homogeneous material denoted by:
 $\rho = M / V$ (g/cm³) where M = mass (g) and V = volume (cm³).

Bulk density (ρ_b) is the mass of a unit volume of material in its natural state (with pores / voids) calculated as $\rho_b = M / V$ (Kg/m³)

where M = Mass of specimen (Kg) and V = Volume of specimen in its natural state (m³).

Density & Bulk density of some building materials are as follows:

Material	Density (g/cm ³)	Bulk density (Kg/m ³)
Brick	2.5 – 2.8	1600 - 1800
Granite	2.6 – 2.9	2500 - 2700
Portland cement	2.9 – 3.1	
Wood	1.5 – 1.6	500 - 600
Steel	7.8 – 7.9	7850
Sand		1540 - 1650

Density Index (P_o) is the ratio between the bulk density and density ie. $P_o = \rho_b / \rho$
Density index indicates the degree to which the volume of a material is filled with solid matter. For almost all building materials *P_o is less than 1.0 because there are no absolutely dense bodies in nature.*

In addition, Percentage wear, resistance to fire, dressing etc are also to be considered for a good building stone.

DRESSING OF STONE:

The stones, after being quarried, are to be cut into suitable sizes and this process is known as the dressing of stones. The dressing of stones is carried out for the following purposes:

A quarried stone has rough surfaces, which are dressed to obtain a definite and regular shape.

To make the transport from quarry easy and economical.

Provides pleasing appearance

To suite to the requirements of stone masonry.

QUARRY DRESSING: At the quarry place, the stones are roughly dressed to secure the following advantages:

- At quarry site, it is possible to get cheap labour for the process of dressing of stones.

- It is possible to sort out stones for different works
- The irregular and rough portions of the stones are removed which decrease the weight of stones.

Following are the varieties of finishes obtained by the dressing of stones:

Dragged (or Combed finish): In this type of finish, a piece of steel which is similar to a comb is rubbed on the surface in all directions and surface of the stone. This finish is suitable for soft stones only.

Punched finish: On the stone surface, the depressions are made by using a punch. The surface of the stone takes the form of a series of hollows and ridges.

Reticulated finish: This type of finish represents a net – like appearance. A margin about 20 mm wide is marked on the edges of stone and irregular sinking's are made on the enclosed space. A pointed tool is used to put the marks on the sunk surface so as to present a pock – marked appearance.

Tooled finish: The stone surface is finished by means of a chisel and parallel continuous marks either horizontal or inclined or vertical are left on the surface.

Rock faced (self – faced) finish: Some stones, as obtained from the quarry, possess smooth surface and they can be directly placed on the work. Such a stone surface is termed as Rock – faced (or) quarry – faced finish.

Vermiculated finish: This finish is similar to reticulated type except that the sinking's are more curved.

ARTIFICIAL STONES: Where durable natural stone is not available at reasonable cost, artificial stone, also known as CAST STONE becomes the choice. Artificial stone is made with cement and natural aggregates of the crushed stone and sand with desired surface finish. Suitable color pigments may be added. Following procedure is generally adopted in making an artificial stone:

- The natural stone is crushed into sizes less than 6 mm
- A mixture of 1½ parts of stones of size 3 – 6 mm; 1 ½ parts of stones of size < 3mm and 1 part of cement by volume is prepared.
- The necessary pigment is added to produce the desired color effect to the above mixture.
- Required quantity of water is added and thorough mixing is done.
- The mixture thus prepared is transferred to special moulds.
- The mixture is allowed to harden and its surface is kept wet.
- The artificial stone is then ready in block form.
- Polishing can be done if required.

FORMS OF ARTIFICIAL STONES:

Cement Concrete: This is a mixture of cement, fine aggregate, coarse aggregate and water. If steel is used with cement concrete, it is known as the Reinforced Cement Concrete (RCC). Concrete blocks are used in construction of piers, steps, window sills etc...

Mosaic Tiles: The pre-cast concrete tiles with marble chips at top surface are known as the mosaic tiles.

Terrazzo: This is a mixture of marble chips and cement. It is used for bath rooms, residential buildings, temples etc...

Victoria Stones are granite pieces with the surfaces hardened by keeping immersed in soda silicate for about two months.

Ransom Stones are prepared by mixing soda silicate with cement to provide decorative flooring. These are also known as chemical stones. These have compressive strength of about 32 N / mm².

BRICKS

The common brick is one of the oldest building material and it is extensively used at present as a leading material of construction because of its durability, strength, reliability, low cost, easy availability, easy to handle etc..

Bricks are used for building – up exterior and interior walls, partitions, piers, footings and other load bearing structures.

The Great Wall of China (210 BC) was built with bricks. The other examples of the use of bricks in early stage of civilization could be in Rome. A number of country farm houses still exist in Great Britain and profess to be the monuments of the excellent hand – made bricks.

A brick is rectangular in shape and of size that can be conveniently handled with one hand. Bricks may be made of burnt clay or mixture of sand and lime (or) of Portland cement concrete.

The length, width and height of a brick are interrelated as below:

Length of brick = 2 x width of brick + thickness of mortar

Height of brick = width of brick

Size of standard brick (also known as modular brick) should be 19 x 9 x 9 cm. However, the bricks available in most part of the country still are 9" x 4 ½" x 3" and are known as field bricks. Weight of such a brick is 3.0 kg.

An indent called **frog**, 1 – 2 cm deep is provided for 9 cm height bricks only. The purpose of providing frog is to form a key for holding the mortar and therefore, the bricks are laid with frogs on top. Frog is not provided in 4 cm high bricks



COMPARISION OF BRICKSTONE AND STONWORK:

The brickwork is superior to the stonework in the following respects:

- At places where stones are not easily available but where there is plenty of clay, brickwork becomes cheaper than stonework.
- The cost of construction works out to be less in case of brickwork than stonework as less skilled labour is required in the construction of brickwork.

- No lifting devices are necessary to carry bricks as they can be easily moved by manual labour.
- The bricks resist various atmospheric effects better than stones.
- In case of brickwork, the mortar joints are thin and hence the structure becomes more durable.
- It is easy to construct connections and openings in case of brickwork than stonework.

CHARACTERISTICS OF GOOD BRICK:

The essential requirements for building bricks are sufficient strength in crushing, regularity in size, and a pleasing appearance when exposed to view.

Size and shape: The bricks should have uniform in size, rectangular surfaces with parallel sides and sharp straight edges.

Color: The brick should have a uniform deep red (or) cherry colour as indicative of uniformity in chemical composition and thoroughness in the burning of the brick.

Texture and compactness: The surfaces should not be too smooth to cause slipping of mortar. The brick should have uniform texture and should not show fissures, holes etc..

Hardness and soundness: The brick should be so hard that when scratched by a finger nail no impression is made. When two bricks are struck together, a metallic sound should be produced.

Water Absorption should not exceed 20% of its dry weight when kept immersed in water for 24 hours.

Crushing Strength should not be less than 10 N / mm².

Brick earth should be free from stones, Kankars, Organic matter, salt petre etc..

COMPOSITION / INGREDIENTS OF GOOD BRICK EARTH: For the preparation of bricks, clay is usually used. The clay used for brick making consists mainly of silica and alumina mixed in such a proportion that the clay becomes plastic when water is added to it. It also consists of small proportions of lime, iron, magnesium, sulphur etc.. The proportions of various ingredients and functions are as follows:

Silica 50 – 60 %

Alumina 20 – 30 %

Calcium 10 %

Mg < 1 %

Ferric Oxide < 7 % < 20 %

Alkalis < 10 % < 20 %

SO₃; H₂O < 2 % < 20 %

Silica: A good brick earth should contain about 50% to 60% of silica. The presence of silica constituent prevents cracking, shrinking in bricks thus imparts uniform shape to the bricks. Excess of silica makes the brick brittle and weak on burning. The durability of bricks depends on the proper proportion of silica in brick earth.

Alumina: A good brick earth should contain about 20 to 30% of alumina. If alumina is present in excess, with inadequate quantity of sand the raw bricks shrink and it produces cracks during drying and burning and become too hard when burnt.

Lime (calcium) : A small quantity of lime not exceeding 10% is desirable in good brick earth. The excess of lime causes the brick to melt and hence its shape is lost and also results in splitting of bricks into pieces.

Magnesia if exceeds 1%. affects the color and makes the brick yellow. Excess

of magnesia content leads to the decay of bricks.

Iron – oxide usually constitutes < 7% . If it exceeds 7%, the brick becomes dark blue. When excess of oxygen is available, the bricks becomes dark brown or black color on burning.

HARMFUL SUBSTANCES IN BRICK EARTH: Following are the ingredients which are undesirable in the brick earth:

LIME: When lime is present in lumps, it absorbs moisture, swells and causes disintegration of the bricks.

PEBBLES, GRAVELS: The presence of pebbles of any kind is undesirable in brick earth because it will not allow the clay to be mixed uniformly and thoroughly which will result in weak and porous bricks. Also the brick containing pebbles will not break regularly as desired.

ALKALIES: These are mainly in the form of soda and potash. When alkalies present in excess, the bricks become unsymmetrical / loose their shape. Further, the presence of excess alkalies content absorb moisture from the atmosphere. Such moisture, when evaporated, leaves behind grey or white deposits on the wall surface and the appearance of the building as a whole is then seriously spoiled.

ORGANIC MATTER: The presence of organic matter in the brick earth, which is not burnt in case, the bricks become porous and the strength is reduced.

SURPHUR & CARBON: Sulphur is usually found in clay as the sulphates of Calcium (CaSO_4); magnesium (MgSO_4); Sodium (NaSO_4); Potassium (K_2SO_4) and iron sulphides (FeS_2). If, however, there is carbon in the clay and insufficient time is given during burning for proper oxidation of carbon and sulphur, the latter will cause the formation of a spongy, swollen structure in the brick.

MANUFACTURING OF BRICKS

In the process of manufacturing of bricks, the following four distinct operations are involved: 1. Preparation of clay / Brick earth

2. Moulding
3. Drying
4. Burning

1.PREPARATION OF CLAY / BRICK EARTH consists of the following operations:

a) *Un-soiling:* The soil used for making building bricks should be processed and to be free from gravel, sand (> 2 mm) lime and kankar particles, organic matter etc.

About 200 mm of the top layer of the earth, normally containing stones, pebbles, gravels, plant roots etc is removed after clearing the trees and vegetation.

b) *Digging:* The clay is then dug out from the ground and is spread on the ground. The height of heaps of clay on the ground is about 600 mm to 1200 mm. The digging operation should be done before rains.

c) *weathering:* The clay / soil is left in heaps and exposed to weather for atleast one month. The soil should be turned over at least twice and it should be ensured that the entire soil is wet throughout the period of weathering.

In order to keep it wet, water may be sprayed as often as necessary. The plasticity and strength of the clay are improved by exposing the clay to weather.

d) *Blending*: The clay / soil is then mixed with sand and calcareous earth in suitable proportions to modify the composition of soil uniformly with spades. Addition of water to the soil at the dumps is necessary for easy mixing and workability. However, the excessive moisture content may affect the size and shape of the finished brick.

The blending makes clay fit for the next stage of tempering.

e) *Tempering*: In the process of tempering, the clay is brought to a proper degree of hardness. The tempering should be done exhaustively to obtain homogeneous mass of clay of uniform character..

For manufacturing good bricks, tempering is

done in **Pug Mills** and the operation is

called **Pugging**. In other words, the process

of grinding clay with water and making it

plasticity is known as the Pugging

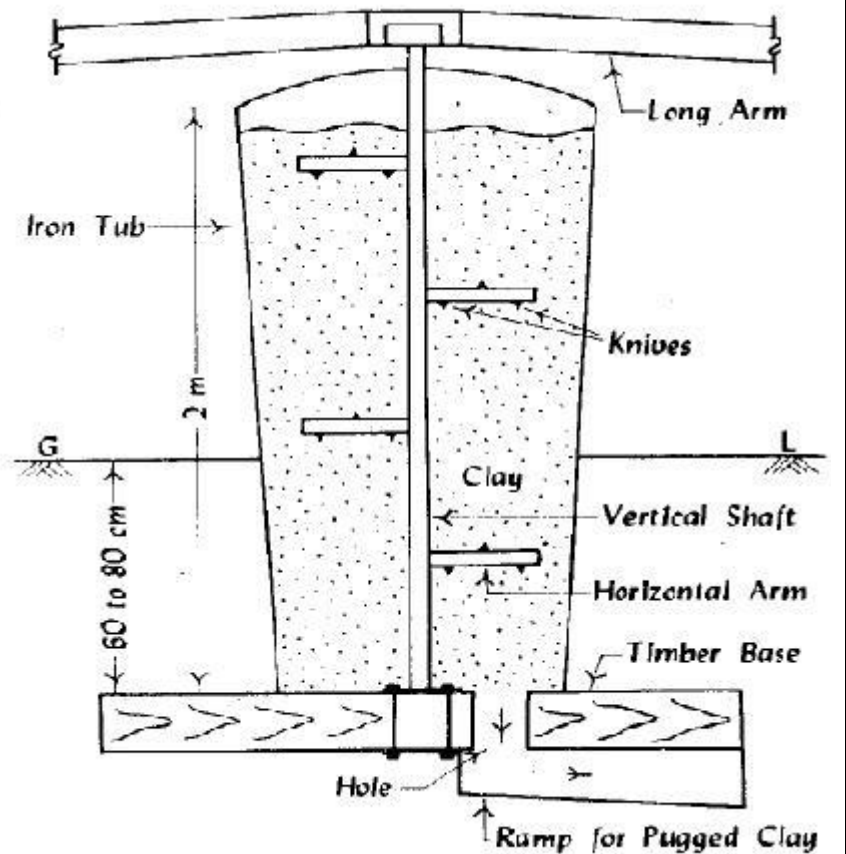

Fig: Pug Mill

2.MOULDING: It is a process of giving a required shape to the brick from the prepared clay / soil / brick earth. *Moulding may be carried out by hand or by machines.*

Hand Moulding: In this process, the bricks are moulded by hand ie manually. It is adopted where man power is cheap and for producing a small quantity of bricks. A typical wooden mould should be prepared from well seasoned wood for making bricks.

The longer sides are kept slightly projecting to serve as handles. The strips of brass or steel are sometimes fixed on the edges of wooden moulds to make them more durable.

The steel mould even be prepared from steel angles and plates. The thickness of steel mould is generally 6 mm.

The bricks prepared by **hand moulding** are of two types:

- (a) Ground - moulded bricks
- (b) Table – moulded bricks

Ground – Mould bricks: In this process, the ground is leveled and sand is sprinkled on it. The mould is dipped in water and placed over the ground. The clay is pressed or forced in the mould in such a way that it fills all the corners of the mould. The extra or surplus clay is removed with a sharp edged metal plate called *STRIKE* or with a thin wire stretched over the mould. After this process, the moulded bricks are left on the ground for drying. The bricks prepared by dipping mould in water every time are known as the slopmoulded bricks. The fine sand or ash may be sprinkled on the inside surface of mould, instead of dipping mould in water is known as Sand – Moulded bricks.

Table Moulding: the process of moulding these bricks is just similar to ground moulding. But in this process, the clay, mould, water pots, strikes, pallet boards are placed on the table. A thin board called *pallet* is placed over the mould. The bricks are moulded on the table and sent for the further process of drying. The cost of brick moulding also increases slightly when table moulding is adopted.

Machine Moulding: The moulding may also be achieved by machines. It proves to be economical when bricks in huge quantity are to be manufactured at the same spot in a short time. Machine moulding can be done by either of the following process:

Plastic method (Plastic Clay Machine): The pugged clay is placed in the machine through a rectangular opening by means of an auger. Clay comes out

of the opening in the form of a bar. The bricks are cut from the bar by a frame consisting of several wires at a distance of brick size and this is a quick and economical process. This process is also known as WIRE CUT BRICKS.

Dry Press Method / Dry Clay Method: In these machines, the strong clay is first converted into powder form. A small quantity of water is added to form a stiff plastic paste. Such paste is placed in mould and pressed by machine to form hard and well shaped bricks. These bricks are also known as PRESSED BRICKS. They can be sent directly for the next process of burning.

3.DRYING: For drying, the bricks are laid longitudinally in stacks of width equal to two bricks. A stack consist of 8 or 10 tiers or courses. The bricks are laid along and across the stack in alternate layers. All bricks are placed on edge. The bricks in stakes should be arranged in such a way that sufficient air space is left between them. The bricks should be allowed to dry till they become hard or the moisture content is brought down to about 3% under exposed conditions within 3 to 4 days.

For the drying purpose, Drying yards should be prepared. The Drying yards should be slightly on a higher level and it is desirable to cover it with sand. Such an arrangement would prevent the accumulation of rain water.

3. BURNING: This is a very important operation in the manufacture of bricks. The burning of clay may be divided into three main stages.

Dehydration stage (400 – 650°C): This is also known as *water smoking stage*. During dehydration :

- The water which has been retained in the pores of the clay after drying is driven off;
- Some of the carbonaceous matter is burnt;
- Carbonated minerals are more or less decarbonated;
- Too rapid heating causes cracking or bursting of the bricks.

Oxidation period (650 – 900°C): During the oxidation period, the remaining carbon is eliminated and the ferrous iron is oxidized to the ferric form.

Removal of sulphur is completed only after the carbon has been eliminated.

Vitrification (upto 1100°C): When the temperature is reached about 1100°C, the two important constituents viz., alumina and sand bind themselves together

resulting in the increase of strength and density of bricks. If the temperature is raised beyond 1100°C, a great amount of fusible glassy mass is formed and the bricks are said to be vitrified.

The bricks begin to lose their shape beyond a certain limit of vitrification.

Burning of bricks is done in a **Clamp or Kiln**. A Clamp is a temporary structure whereas Kiln is a permanent one.

Burning in Clamps (Pazawah): A piece of ground with trapezoidal shape is selected. The alternate bricks and fuel are placed in layers. The fuel may consist of grass, cow dung, litter, husks of rice or ground nuts etc.. The thickness of this fuel layer is about 700 – 800 mm. The wood or coal dust may also be used as fuel.

Each brick tier consists of 4 – 5 layers of bricks. The total height of a clamp is about 3 – 4 mts.

When nearly 1/3 rd height is reached, the lower portion of the Clamp is ignited.

When the Clamp is completely constructed, it is plastered with mud on sides and top and filled with earth to prevent the escape of heat.

The Clamp is allowed to burn for a period of about one to two months and then it is allowed to cool more or less of the same period as burning. The burnt bricks are then taken out from the clamp.

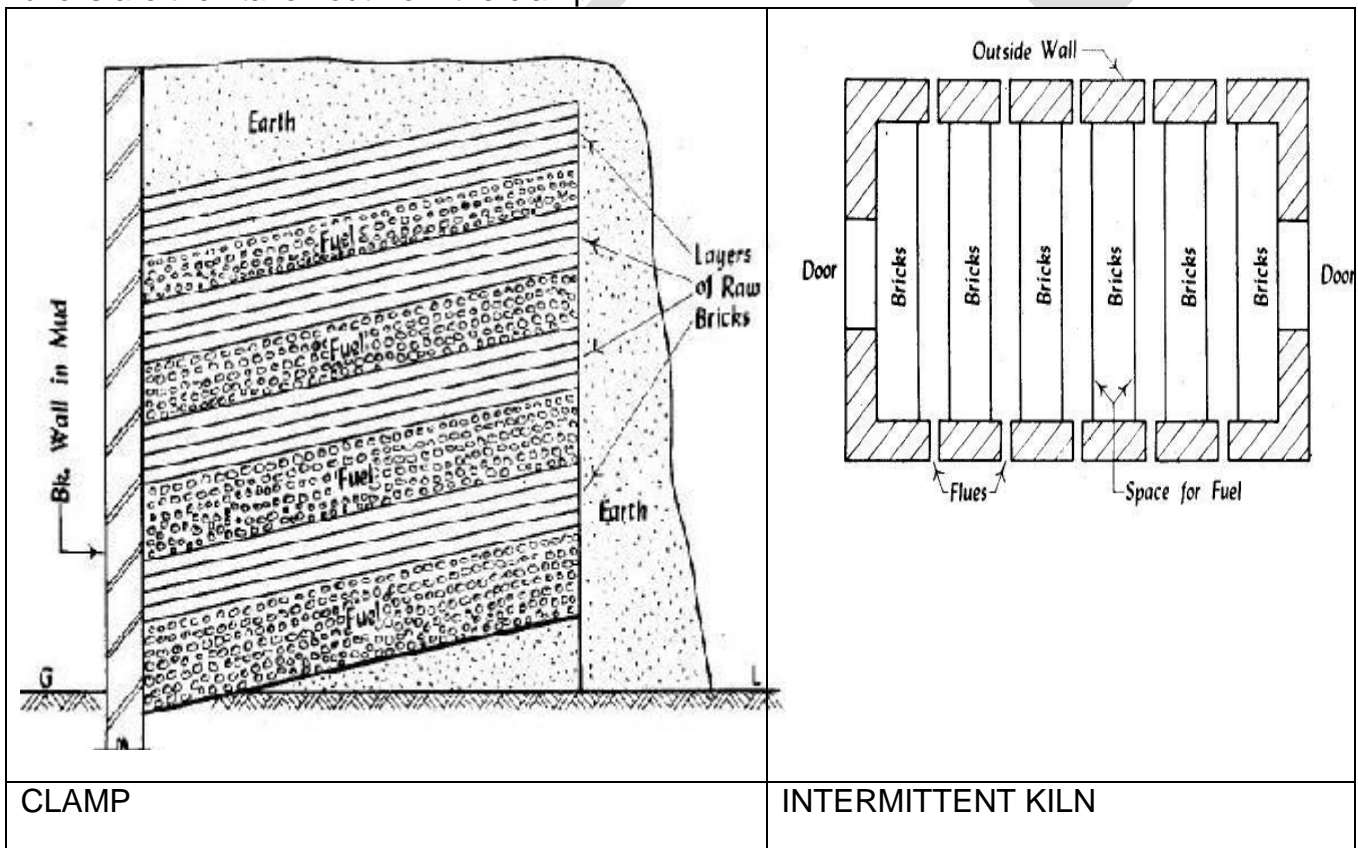

The production of bricks is 2 – 3 lakhs and the process is completed in 6 months. This process yields about 60% first class bricks.

Kiln burning: A kiln is a large oven which is used to burn bricks. The Kiln used for burning bricks may be underground (Bull's Trench Kiln) or over ground (eg: Hoffman's Kiln). The Kilns may be rectangular, circular or oval in shape.

The Kilns are of two types: (i) Intermittent Kilns (ii) Continuous kilns

INTERMITTENT KILNS: The process of burning bricks is discontinuous and hence, the kiln is known as intermittent kiln which means that they are loaded, fired, cooled and unloaded and then the next loading is done. Since the walls and sides get cooled during reloading and are to be heated again during next firing, there is wastage of fuel. They may be over ground or underground.



Fly ash Bricks

Fly ash bricks are masonry units that are used in the construction of buildings. They are considered to be a part of good and affordable building materials. They contain Class C fly ash and water.

Fly ash bricks are made by compressing Class C fly ash and water at 4000psi and then curing is carried on for 24 hours at a temperature of 66 degrees Celsius steam bath. Air entrainment agent is used to toughen the bricks.

GREEN BRICKS

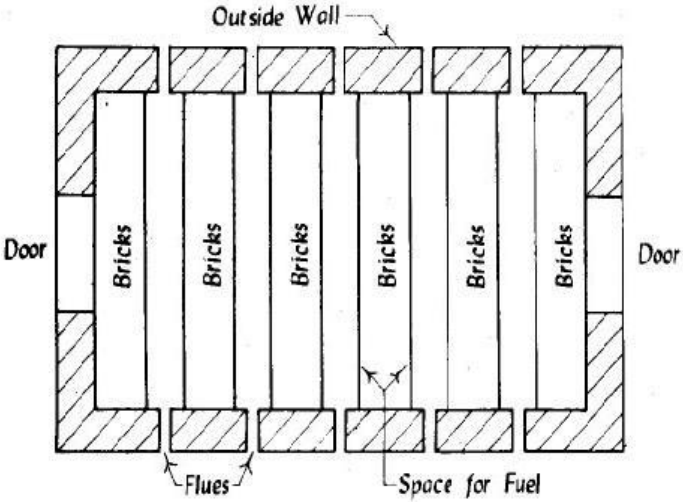
The bricks are used like conventional clay bricks – for building things from houses to factories. They're called green because they are built from a toxic byproduct produced from coal-burning power plants. Instead of these toxins being released into the environment, or disposed of through costly means, they're pumped into the bricks. The waste product is called fly ash. It's loaded with mercury, lead, and other toxic chemicals. Coal-burning power plants spend millions of dollars to dispose of the powdery byproduct. Until now, the estimated 70 million tons of byproduct has been buried in specially designed ponds and waste centers.

 <p>The diagram illustrates a cross-section of an intermittent kiln. It features an 'Outside Wall' at the top, two 'Door's on the left and right sides, and a series of vertical 'Bricks' in the center. Below the bricks are 'Flues' and a 'Space for Fuel'.</p>	 <p>A photograph showing a close-up of several green bricks, which are made from fly ash. The bricks are rectangular and have a distinct green color.</p>
INTERMITTENT KILN	GREEN BRICKS

CONTINUOUS KILNS: The process of burning bricks is continuous, and hence it is known as continuous kiln (eg: Bull's Trench Kiln and Hoffman's Kiln). In this process, bricks are stacked in various chambers wherein the bricks undergo different treatments at the same time. When the bricks in one of the chambers is fired, the bricks in the next set of chambers are dried and preheated while bricks in the other set of chambers are loaded and in the last are cooled.

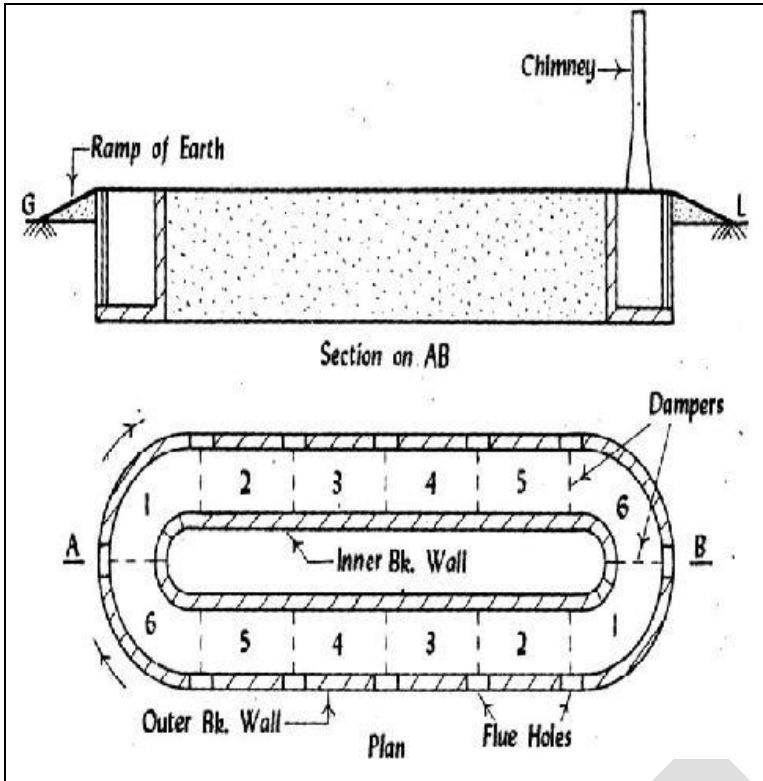

BULL'S TRENCH KILN

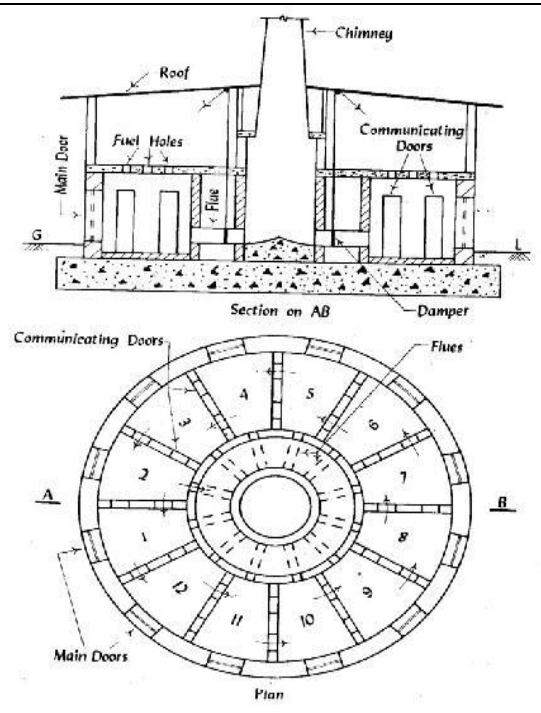

HOFFMAN'S KILN

TUNNEL KILN :

A tunnel kiln useful for burning vertically perforated green bricks, includes a furnace chamber; tubular burners for heating the furnace chamber and a transport device for transporting green bricks in raster-like spaced-apart relationship in a travel direction through the furnace chamber that the perforations of the green bricks are oriented in a common direction..

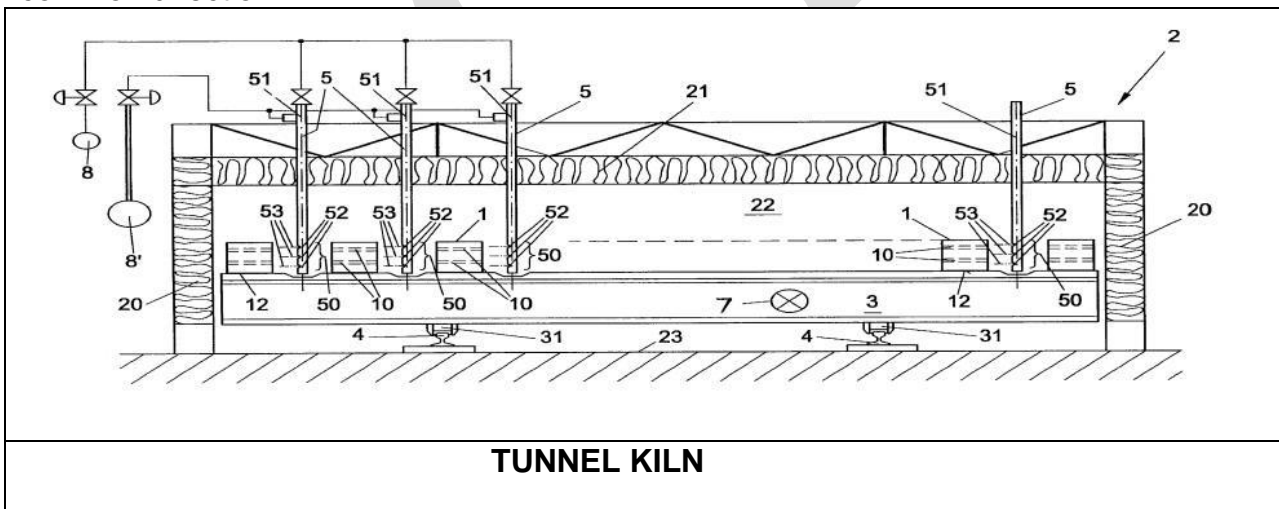

TUNNEL KILN

Bull's Trench Kilns

In **India**, brick making is typically a manual process. The most common type of brick kiln in use there are **Bull's Trench Kiln (BTK)**, based on a design developed by British engineer W. Bull in the late 19th century.

An oval or circular trench, 6–9 meters wide, 2-2.5 meters deep, and 100–150 meters in circumference, is dug. A tall exhaust chimney is constructed in the centre. Half or more of the trench is filled with "green" (unfired) bricks which are stacked in an open lattice pattern to allow airflow. The lattice is capped with a roofing layer of finished brick.

In operation, new green bricks, along with roofing bricks, are stacked at one end of the brick pile; cooled finished bricks are removed from the other end for transport. In the middle the brick workers create a firing zone by dropping fuel (coal, **wood**, oil, debris, and so on.) through access holes in the roof above the trench.

The advantage of the BTK design is a much greater energy efficiency compared with clamp or scove kilns. Sheet metal or boards are used to route the airflow through the brick lattice so that fresh air flows first through the recently burned bricks, heating the air, then through the active burning zone. The air continues through the green brick zone (pre-heating and drying them), and finally out the chimney where the rising gases create suction which pulls air through the system. The reuse of heated air yields savings in fuel cost.

A half dozen laborers working around the clock can fire approximately 15,000-25,000 bricks a day. In the BTK process the bricks do not move. Instead, the locations at which the bricks are loaded, fired, and unloaded gradually rotate through the trench.

TESTS FOR BRICKS:

A brick is generally subjected to the following tests to find out its suitability for the construction work:

Water Absorption Test (US 3495):: A brick is taken and it is weighed dry. It is then immersed in water for a period of 48 hours. It is weighed again and the difference in weight indicates the amount of water absorbed by the brick. It should not, in any case, exceed 5% of weight of dry brick.

Compressive Strength Test (IS: 3495): The crushing strength of a brick is found out by placing in a compression testing machine. It is pressed till it breaks. The minimum crushing or compressive strength of bricks is 3.50 N / mm².

Efflorescence Test: The brick is immersed in water for 24 hours. It is then taken out and allowed to dry in shade. The absence of grey or white deposits on its surface indicates the absence of soluble salts.



If the white deposits cover about 10% surface, the efflorescence is said to be slight and it is considered as moderate when the white deposits cover about 50 % of surface.



If grey or white deposits are found on more than 50 % of surface, the efflorescence becomes heavy and it is treated as serious.

Soundness: In this test, the two bricks are taken and they are struck with each other. The bricks should not break and a clear ringing sound should be produced.

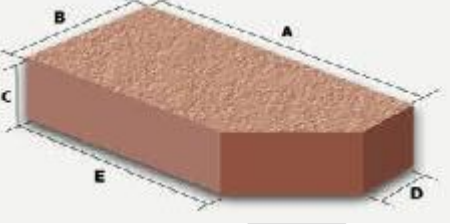
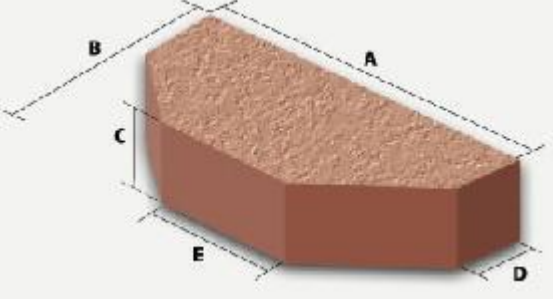
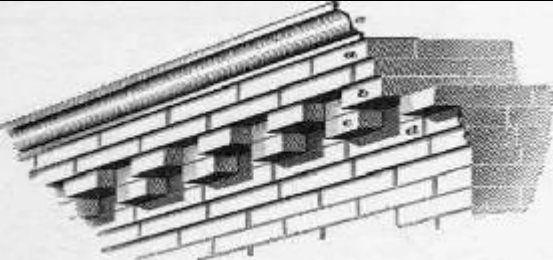
DIFFERENT FORMS OF BRICKS:

Various forms of bricks are used depending upon the places of use. For eg:

Round ended bricks	Used to construct open drains	
Bull nosed bricks	Used to construct open drains	
Cant (splay) brick	Used for Door and window jambs	
Double cant bricks	Used for Octagonal pillars	
Cornice brick	Used for architectural point of view	
Fire brick	<p>firebrick, or refractory brick is a block of refractory ceramic material</p> <p>used in lining furnaces, kilns, fireboxes, and fireplaces. A</p>	

	<p>refractory brick is built primarily to withstand high temperature.</p>	
Coping bricks	Used for parapets	
Perforated bricks	<p>The perforated bricks are used in roadways in order to drain of the rain water from the streets</p>	
Hollow bricks	<p>Hollow bricks which are highly used in construction of houses, buildings and compound walls.</p>	
frog	<p>providing frog is to form a key for holding the mortar on the bricks</p>	

<p>Gun powder</p>	<p>A mixture of charcoal, salt petre (KNO_3) and sulphur and</p> <p>the proportions by weight are 15, 75 and 10 respectively</p>	
<p>Magazine</p>	<p>A special type of building meant for storing the explosives</p>	
<p>Masonry</p>	<p>Masonry may be defined as the construction of building units (such as stones, bricks or precast blocks of concrete) bonded together with mortar.</p>	
<p>Metamorphism</p>	<p>The process by which the changes are brought in solid rocks by the agencies of temperature, pressure and chemical active solutions which in turn establish a new equilibrium</p>	
<p>Mortar</p>	<p>Mortar is a homogeneous mixture produced by uniform mixing of cement or lime or combination of these two in addition to sand and water to make a paste of required consistency</p>	

Weathering	which is a natural process of disintegration and decomposition	
Strike	The extra or surplus clay is removed with a sharp edged metal plate called <i>STRIKE</i>	
Pugging	the process of grinding clay with water and making it plastic is known as the Pugging.	
Pallet	A thin board called <i>pallet</i> is placed over the mould	

WOOD, ALUMINIUM, GLASS AND PAINTS

Wood is a hard fibrous substance which forms a major part of the trunk and branches of a tree. Trees are classified as endogenous and exogenous according to the mode of growth:

TREES

Exogenous		Endogenous
<p>Trees grow outwards and are used for making structural / engineering purpose. These trees are characterized by the distinct consecutive rings in the Horizontal section of such a tree. These rings are known as the annual rings (<i>counting number of rings</i>) because one such ring is added every year and these rings are useful in predicting the age of the tree. These trees are subdivided into :</p>		<p>Trees grow end wards means the trees grow inwards. Eg; Palm; Bamboo, Cane</p>
<p>Coniferous(soft wood):</p> <p>These are ever green trees having <i>pointed needle like</i></p>	<p>Deciduous(hard wood)</p> <p>These trees have flat board leaves. Eg: Eucalyptus; Oak, Teak,</p>	

leaves. Eg; Deodar, Chir, Fir, Kail, Pine, Babul, Sal; Jack tree... These trees show distinct annual rings and are soft (except pine), light in color and light weight.	(Ben teack); Polar, Maple, Shishum. These trees show indistinct annual rings and are hard and non- resinous, dark in color and heavy weight. Trees grow end wards means the trees grow inwards. Eg; Palm; Bamboo, Cane	
---	---	--

Wood has many advantages due to which it is preferred for building material. Teak is not suitable for making construction of bridge works whereas Babool, Sal etc are suitable for making construction of bridges. Babool tree is also used for making agricultural implements. Ben teak is used for making boats while Deodar trees are meant for making railway sleepers. Jack trees is used for making musical instruments.

Wood is easily available and easy to transport and handle. Wood is a good absorber of shocks and so is suitable for construction works. Wood can be easily repaired and alterations to wood work can also be done easily. Owing to the above mentioned advantages, wood is very widely used in buildings as doors, windows, frames, temporary partition walls etc..

CLASSIFICATION OF TIMBER / WOOD:

Wood as a building material falls in two major classes—natural and manmade. Natural form of a wood is timber whereas man-made wood is plywood, fibre board, chipboards, compressed wood, impregnated wood etc. The terms timber and wood are often used as synonymous. Following is the classification of timber as IS: 399:

(1) **On the basis of its position:**

- Standing timber implies a living tree.
- Rough timber forms a part of the felled tree
- Converted timber are logs of timber

(2) **On the basis of Grading (IS: 6534):**

All grading specifications are clearly distinguished between structural grading and commercial grading based on Indian Standard Classification:

Structural grading is also known as Stress grading. It refers that the material is graded on the basis of visible defects.

Commercial grading is also known as Yard grading or Utility grading refers that the material is graded by consideration of usefulness of the material and price factors. Commercial grading is further divided in the following classes:

Grade – A: This classification is based on dimensions and general appearance. The dimensions of lengths, widths and thicknesses of converted materials are measured.

Grade – B: This classification is based on the best ultimate use of the material.

Grade – C: This classification is based on qualitative (evaluation of defects) and rough estimate of out – turn of utilizable material.

Grade – D: This classification is based on fixing the permissible standard volume of area. This method is increasingly adopted in Indian Standards and is recognized internationally.

(3) **On the basis of Modulus Elasticity:**

The species of timber recommended for constructional purpose are classified as:

Group – A: Modulus Elasticity in bending above 12.5 kN / mm²

Group–B: Modulus Elasticity in bending above 9.8 and below 12.5 kN / mm²

Group–C: Modulus Elasticity in bending above 5.6 and below 9.8 kN / mm²

(4) **On the basis of Availability:** According to availability, timber can be of three grades, namely x, y and z.

X – most common, 1415 m³ or more per year.

Y – common, 355 to 1415 m³ or more per year.

Z – less common, below 355 m³ or more per year.

(5) **On the basis of durability:**

Test specimens of size 600 x 50 x 50 mm are buried in the ground to half their lengths. The conditions of the specimen at various intervals of time are noted and from these observations, their average life is calculated as:

- High-durability average life of 120 months and over.
- Moderate durability average life of < 120 but of 60 months or more.
- Low durability average life of less than 60 months.

(6) On the basis of treatability:

This classification is based upon the resistance under a working pressure of 1.05 N / mm² as follows:

- (i) Easily treatable and (ii) Only partially treatable.

STRUCTURE OF A TREE : A tree can be divided into three portions namely CROWN—composed of branches and leaves

TRUNK—to support the crown and to supply water and nutrients

ROOTS—are meant to implant the trees in the soil, to absorb moisture and to supply to the trunk.

From the visibility aspect, the structure of a tree can be divided into two categories:

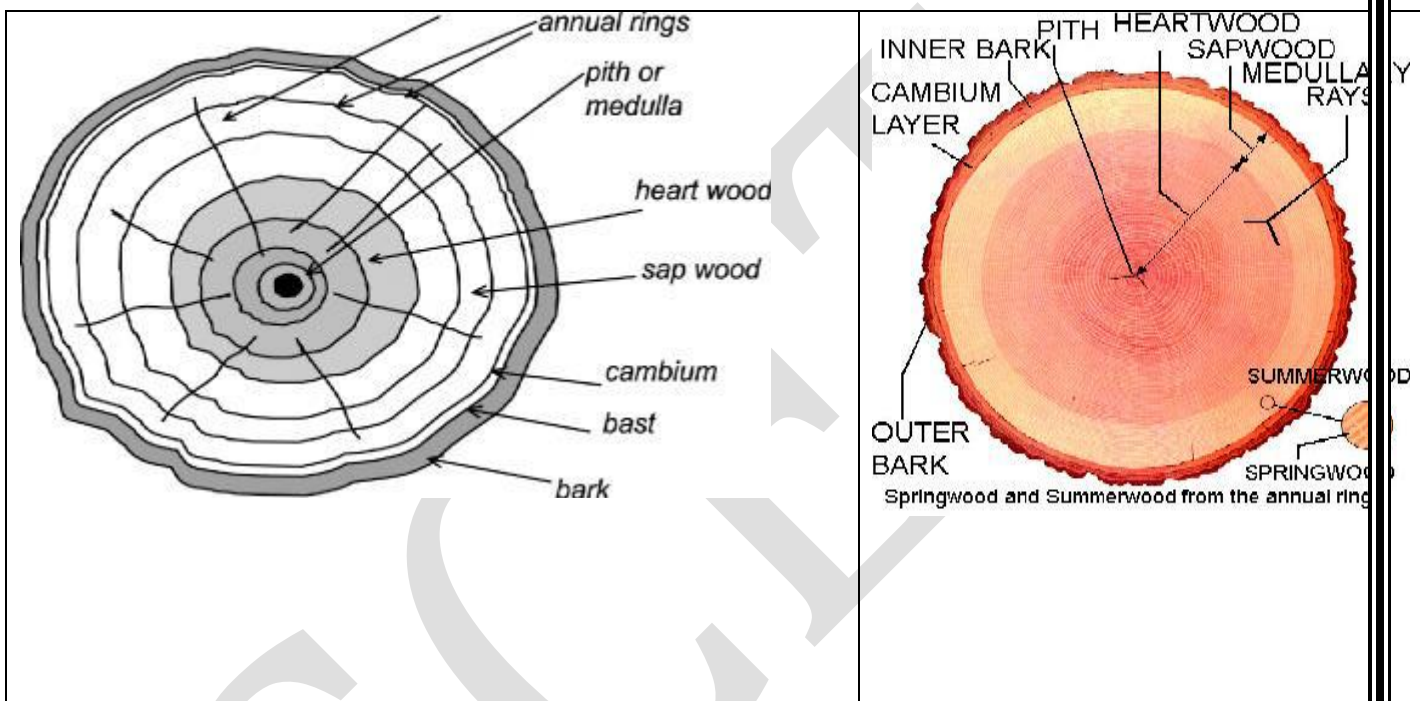

Macrostructure: The structure of timber visible to naked eye or at a small magnification is called macrostructure.

Microstructure: The structure of timber apparent only at great magnifications is called the micro-structure. Microstructure depicts the following:

Bark: protects the wood against mechanical damage. The outer skin of the tree is known as the outer bark. It is a protective layer and it sometimes contain cracks.

Bast (medulla) : inner layer of bark, which conveys the nutrients from the crown downwards and stores them.

Pith: the inner most central portion of the tree is called the pith. It consists entirely of cellular tissues which are thin and connected loosely.

Heartwood: The inner rings surrounding the Pith is called as heartwood which is usually in dark color. It gives a strong & firm support to the tree.

Sapwood: The outer rings between heartwood and cambium layer is known

as the sapwood. It is usually light in color. The sapwood assists in the life process of tree by storing up starch. It takes active part in the growth of tree.

Cambium layer: The thin layer between sapwood and inner bark (bast) as the Cambium layer. The function of cambium is to grow wood cells.

SEASONING OF TIMBER:

Seasoning is the process of reducing the moisture content (drying) of timber in order to prevent the timber from possible fermentation and making it suitable for use.

It can also be defined the process of drying of timber is known as the seasoning of timber. The moisture in timber can be present either in the cell cavities or in the cell walls. The former is known as the free moisture and major part of moisture in timber is present as free water. The latter is known as the bound moisture and it is closely associated with the body of timber.

The moisture content of timber is determined as follows:

$P = (W1 - W2 / W2) \times 100$ where P= percentage of moisture

W1= original weight of timber.

W2= oven dry weight of timber.

Some of the objects of seasoning wood are as follows:

- Reduce its tendency to split and decay
- Reduce its weight.
- Increases strength, durability and workability.
- Make it suitable for painting
- To burn readily, if used as fuel.
- To maintain the shape and size of the components of the timber articles.
- To make timber safe from the attack of fungi and insects.

METHODS OF SEASONING: Timber can be seasoned naturally or artificially

Natural Seasoning (Air Seasoning): The timber in log form is not usually fit for the process of seasoning. Hence, it is cut and sawn into suitable sections of planks.

The timber pieces can either be stacked horizontally or vertically so as to permit free circulation of air and the minimum distance between adjacent stacks should be atleast 600 mm.

The duration for drying depends upon the type of wood and the size of planks.

Air seasoning reduces the moisture content of the wood to 12-15%

Advantages:

- Depending upon the climatic conditions, the moisture content of wood can be brought down to about 10%
- It does not require skilled supervision.
- The method of seasoning timber is cheap and simple.

Disadvantages:

- The drying of different surfaces may not be even and uniform.
- If not properly attended, the fungi and insects may attack timber during the process of seasoning and may damage it.
- The moisture content of wood may not be brought down to the desired level.

Artificial Seasoning: The various methods of artificial seasoning are as follows:

1. Boiling: Boiling in water or exposing the wood to the action of steam spray is a very quick but expensive process of seasoning.

2. Water Seasoning: The logs of wood are kept completely immersed in stream of water, with their larger ends pointing upstream. Consequently, the sap, sugar and gum are leached out and are replaced by water. The logs are then kept out in air to dry. It is a quick process but the elastic properties and strength of wood are removed.

3. Kiln seasoning: This method is adopted for rapid seasoning of timber on large scale to any moisture content. The scantlings are arranged for free circulation of heated air or with steam. Two types of kilns viz the *progressive and the compartment* are in use.

4. Electrical Seasoning: The logs are placed in such a way that their two ends touch the electrodes. Current is passed through the set up, being a bad conductor, wood resists the flow of current, generating heat in the process, which results in its drying. The drawback is that the wood may split.

5. Chemical Seasoning: (Salt Seasoning) In this method, the timber is immersed in a solution of suitable salt. It is then taken out and seasoned in the ordinary way. Urea solution is preferred rather than salt solution because the common salt acts as a corrosive.

DEFECTS IN TIMBER / DEFECTS DUE TO SEASONING:

Defects can occur in timber at various stages during the growing period or during the seasoning process. Defects affect the quality, reduce the quantity of wood, reduce the strength, spoil the appearance etc.. However, the defects occurring in the timber are grouped into the following divisions:

(1) **Defects due to Conversion:** During this process of converting the timber into commercial form, the following defects may occur: A wane occurs in timber which contains, on one or more faces or rounded periphery of the trunk. A Torn grain occurs by falling of a tool which causes a small depression.

(2) **Defects due to Fungi:** Fungi attack the timber when the moisture content of timber is above 20% and the presence of air. If the wood is submerged in water, the fungi will not be attacked due to the absence of air in water. Following defects are caused in the timber by the fungi:
Blue Stain: The wood is stained to bluish color.
Dry rot: Fungi attack the wood and convert it into dry powder.
Sap Stain: when wood is exposed to moisture content goes beyond 25%, it loses its color.

(3) **Defects due to Insects:** Termites (white ants), Beetles (small insects) cause rapid decay of timber by converting them into fine powder. On the other hand, Carpenter ants are usually black in color and vary in size. Unlike termites, they do not eat wood but merely tunnel it out for habitation.

Using hydrocyanic acid gas or creosote destroy the insects but they are powerful toxic elements and dangerous to human beings. The best alternative is **turpentine mixed with a small quantity of ortho-dichloro – benzene**. This vapour is very deadly to insects and is not poisonous to

human beings and animals.

(4) Defects due to natural forces / abnormal growth: The main natural forces responsible for causing defects in timber are two namely *abnormal growth and rupture of tissues*. Following are some of the defects commonly found in wood due to natural forces:

Burls (excrescenes) formed when a tree receive a shock or injury in its young age. Due to such injury, the growth of tree is completely absent and irregular projections appear on the body of timber.

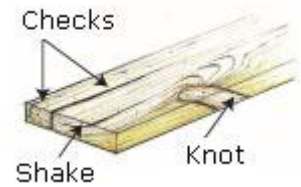

BURL

BURL

Foxiness is a sign of decay appearing in the form of yellow or red tinge or discolouration of over matured trees.

Knots are the bases of branches or limbs which are broken or cut off from the tree. The portion from which the branch is removed receives nourishment from the stem for a long time results in the formation of hard rings which are known as the knots. Presence of knots indicate the weakness.

Rindgalls indicates the abnormal growth when swellings are found on the body of a tree. These develop at points from where branches are improperly cut off or removed.

Shakes: these are cracks which partly or completely separate the fibres of wood and separate the annual rings. Following are the different varieties of shakes:

- Cup shakes – curved crack
- Heat shakes – due to shrinkage and heart wood
- Ring shakes – if the curved crack cover entire ring, it is known as Ring shake
- Star shakes – cracks which extend from bark towards the sap wood.

Twisted fibres are caused by wind constantly turning the trunk of young tree in one direction.

Upsets are also known as the ruptures and they indicate the wood fibres which are injured by crushing or compression.

(5) **Defects due to seasoning:** Following defects occur in the seasoning process of wood:

(1) **Bow:** This defect is indicated by the curvature formed in the direction of length of timber.

(2) **Cup:** This defect is indicated by the curvature formed in the transverse direction of timber.

(3) **Check:** A check is a crack which separates fibres of wood.

(4) **Honey-Combing:** Due to stresses developed during drying, the various radial and circular cracks develop in the interior portion of timber..

(5) **Split:** when a check extends from one end to the other.

(6) **Wrap:** When a piece of timber has twisted out of shape, it is said to have wrapped.

GLASS

As a building material, ceramics include clay, brick, stone, concrete, glass, abrasives, porcelain etc.... ceramics are usually hard and brittle and are in the form of amorphous or glassy solids. On the basis of their internal structure, the ceramics are classified as *Clay products, Refractory's and Glasses*.

Glass is an amorphous substance having homogeneous texture. It is a hard, brittle and transparent material. Ordinary colorless glasses have tensile strength, compressive strength of about 30-60 N/mm² and 700-1000 N/mm² respectively and modulus of elasticity in the range of 0.45 x 10⁵ to 0.8 x 10⁵ N/mm².

The raw materials used in manufacturing of glass are sand (silica) lime (chalk) and soda or potash which are fused over 1100°C. Oxides of iron, lead and borax are added to modify hardness, colour etc.

Silica is used in the form of pure quartz / flint ; lime is in the form of Limestone/chalk; marble and PbO is in the form of galena..

Glass is manufactured in the following steps:

1. **Melting:** The raw materials--- lime, soda and sand separately cleaned, ground.

sieved (called Batch) in definite proportions and mixed with water are fused in a furnace. When the temperature is raised to 1100°C – 1200°C, it turns to a more watery liquid and the bubble rises to the surface.

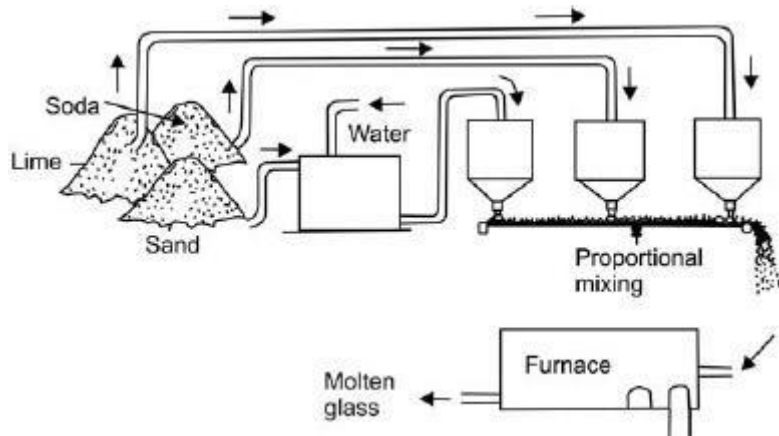
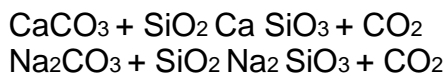

The coloring oxides / salts are added at this stage. Heating is continued till the molten mass is free from bubbles and glass balls. As the glass cools (800°C), it is ready to be drawn to its desired thickness and size at the other end of the furnace.

2. Forming & Shaping: The molten glass can be fabricated to desired shape by adopting blowing or flat drawing methods or in the process of Compression Moulding, Moulds are used to obtain the articles of desired shapes.

In case of *spinning*, the molten glass is spin at high speed by a machine to form very fine glass fibers which is used for providing insulation against heat, electricity....The glass articles, after being manufactured are to be cooled down slowly and gradually. This process of cooling of glass articles is known as the *Annealing of glass*.

3. Finishing: After annealing the glass articles are cleaned, ground, polished, cut to desired ones.

4. Coloring substances for glass: To make colored glass, the coloring pigment is added to the raw materials while preparing the batch for its manufacture. The whole mass is heated till it becomes homogenous. Table shows different substances which are used to produce different shades of color.

Color Substance

Blue
Dark Blue/brown/violet
Green/Emerald green
Red
Violet
Opaque
Yellow
Black
Orange
Greenish yellow

pigment

0.1% cobalt oxide, cupric oxide (CuO)
Cobalt, Mn and Fe oxides.
Ferric oxides (Fe₃O₄) and chromium oxide
Cuprous oxides (Cu₂O)
MnO₂
Tin oxide, Calcium Phosphorite
Antimony trisulphide (Sb₂S₃); charcoal
Oxides of Co and Mn
Selenite and ferric oxide and MnO₂
2 – 3 % of alkali uranate

Classification of Glass and Uses: Depending upon the

constituents, glasses are classified as Soda-Lime glass, Lead glass and Borosilicate glass.

Soda- lime glass is obtained by fusing a mixture of silica, lime and soda. The quality of glass can be improved by adding alumina and Magnesium Oxide and the glass is then called *Crown Glass*. This type of glass is used in doors, windows, bottles etc

Lead glass, also known as *Flint glass* is obtained by fusing a mixture of silica, lead and potash. Lead glass has high shining appearance and not usually affected by temperature. Electric bulbs, optical glasses, ornamental glass and radio valves are some of the articles made from it.

Borosilicate glass is obtained by fusing a mixture of silica, Borax, lime and feldspar. Borosilicate glass can withstand high temperatures and is most suitable for making laboratory equipments .

Some of the important special varieties of glasses are :

Fibre glass: For making this type of glass, the molten glass is spin at a very high speed to produce a continuous fine glass fibres. It is soft and flexible in nature. It doesn't absorb water, acids and is used for motor vehicles as sheets, fibre glass etc....

Bullet Proof glass: This glass is made of several layers of plain glass and alternate layers consist of vinyl-resin plastic. The outer layers of glass are made thinner than the inner layers. The thickness of this type of glass vary from 15mm-75mm. It will not allow bullet to pierce through it.

Ultra-Violet glass: It is made from the raw mixture with minimum quantities of iron, titanium and chrome oxides . Such a glass transmits 75% of UV radiation which is far more than a common glass. It is widely used in windows of schools, hospitals etc....

Glass Blocks: These are completely sealed hollow units which are formed by fusing together two-halves of pressed glass. The glass blocks are available in square sizes with dimensions as 150 x 200 x 300 mm with a thickness of 100mm. These blocks posses high insulating value and are excellent in high transmission and protect against cold, heat and noise.

Other glass varieties include: Float glass; Foam glass; Obscured glass; Perforated glass; Safety glass ; Wired glass etc....

PAINTS

The Paints are coatings of fluid materials and are applied over the surfaces of timber and metals. On drying it forms a thin film (60–150 μ) on the surfaces. The functions of the paint are:

- To protect the coated surface against weathering effects of atmospheric conditions, fumes, gases ...
- Decorate the structure by giving smooth and colorful finish.
- Attack the penetration of water through RCC
- Controls the formation of bacteria and fungus
- Arrests the corrosion of the metal structures
- Stops the decay of wood work
- Provides a smooth surface for easy cleaning.

An ideal paint should have uniform spread as a thin film, high coverage, good workability and durability. The paints should also be cheap and economical

Paints are classified as oil paints, water paints, cement paints, bituminous paints, fire proof paints, luminous paints, chlorinated rubber paints (for protecting objects against acid fumes).

COMPOSITION OF OIL PAINT: An oil paint essentially consists of the following ingredients:

BASE: The base, usually a metallic oxide, is the principal constituent of the paint. It makes the paint film opaque and possesses binding properties which reduce the shrinkage cracks in the film on drying.

Some of the examples of base are White lead ($PbCO_3$), Red lead (PbO), Zinc white (ZnO), Aluminum powder, Iron oxide; Lithophane (zinc sulphide + barytes powder), Titanium White etc..

Lead based paints are in general affected by atmosphere and are not recommended for final coats. *Zinc white* is a weather resistant. Aluminum powder is used as base for all aluminum paints. It is generally used for a priming coat to new wood work. *Lithophane* is cheap and can easily applied on the surfaces. However, when exposed to day light, it changes colour, hence used for interior works only. *Titanium white* is non-poisonous and provides a thin transparent film. It is used for receiving the coat of an enamel.

VEHICLE / CARRIER is also known as binder. Vehicle is an oil to which the base is mixed.

Vehicles are used to make it possible to spread the paint evenly on the surface in the form of a thin layer and to provide a binder for the ingredients of a paint so that they may stick to the surface.

The examples of vehicles are natural oils such as Linseed oil, Nut oil, Poppy oil, and Tung oil.

Linseed oil is the most widely used vehicle and is extracted from flax seeds. It reacts readily with oxygen and hardens by forming a thin film known as

Linnoxyn. Nut oil is extracted from walnuts. Poppy oil is prepared from Poppy seeds. It dries slowly and its colors are long lasting. It is used for making paints of delicate colors. Tung oil (**or**) china wood oil is obtained from a tung tree is superior to linseed oil and is used for preparing paints of superior quality .



Poppy seeds	Poppy seeds	Linseeds	Tung seeds /tree
-------------	-------------	----------	------------------

DRIERS also known as plasticizers (letharge – lead oxide; Lead Acetate; Red Lead— Pb_3O_4 ; MnO_2 ; Co, Zn and lead chromate) are chemicals added to paint. A drier absorbs oxygen from the air and transfers it to the linseed oil, which in turn, gets hardened. The quantity of drier is limited to 8% , excess of it affects the elasticity of paint leading to flaking failure. Red lead is the best for primary coat over steel and metal works . The cost of zinc and lead chromates is high.

PIGMENTS are finely ground mineral, organic substances or ;metal powders and their size from 0.1 to 5.0 microns in diameter. When a desired colour is required than the base of a paint, a colouring pigment is to be added. The common pigments are classified as natural and artificial. The former used for preparing glue paints, putties whereas artificial pigments obtained by chemical processing of raw materials include titanium dioxide, zinc white, lead white, Lithophane, Red lead, etc.

Some of the examples of pigments used to produce the desired colours are:

Tint of paint	Pigment
Black	Graphite
Blue	Indigo, Prussian blue
Brown	Burnt umber
Green	Copper sulphate,
Red	Zinc chrome;
Yellow	yellow ochre

SOLVENTS are also known as thinners used to thin the paints, increase the spread . The common thinning agents used are petroleum, spirit, naphtha and turpentine oil.

ADULTRANTS bring down the overall cost, reduce the weight and increase the durability. Adulterants also help to reduce cracking of dry paint. Barium sulphate, calcium carbonate, magnesium silicate and silica are a few examples. The best adulterant is barium sulphate.

TYPES OF PAINTS: The brief descriptions of various types of paints are:

ALUMINIUM PAINTS consist of aluminum powder as base and are resistant to acid fumes. Aluminum paints are used for painting metal roofs, silos,

machinery, poles, towers and storage tanks and the painted surface is visible even in darkness.

ANTICORROSIVE PAINTS: Linseed oil is used as vehicle. A pigment of CrO_2 ; Pb or red lead or Zinc chrome is taken and after mixing it with some quantity of very fine sand, it is added to the paint. These paints are cheap and last for a long duration.

ASBESTOS PAINT: The main constituent is fibrous asbestos. These paints are used for stopping leakage in metal roofs, painting gutters. Asbestos paint is also called Fire proof paint.

BITUMINOUS PAINT: It is prepared by dissolving asphalt in any type of oil or petroleum or naphtha. The paint presents a black appearance and it is used for painting iron work under water.

CELLULOSE PAINTS is also known as **lacquers**. A cellulose paint hardens by evaporation of thinning agent and thus hardens quickly. Being very costly their use is restricted to painting cars, ships and airplanes.

CEMENT BASED PAINT: It is available in dry powder form. It is waterproof and durable. For external finish, on cement-plastered walls, it is mixed with water before its application. Cement paints are durable, strong & are used on exterior surfaces of buildings. Mixed with boiled linseed oil they are also used over corrugated iron sheets.

BRONZE PAINT: Generally a pigment such as aluminum or copper powder is used in bronze paint. It is highly reflective and is applied over radiators.

CASEIN PAINTS: Casein, a protein substance extracted from milk, curd and is mixed with a base (Lithophone). They are available in powder or paste form. They are used over new plaster surface, walls and ceilings.

RUBBER BASED PAINTS: Rubber is treated with chlorine gas is dissolved in solvent and desired pigment is added. These paints are resistant to acid, and alkalis. Rubber paints are used over concrete and cement plastered surfaces.

PLASTIC EMULSION PAINTS: These are useful in porous and/or wet surface. The emulsion coats are less odorous, non-inflammable, quick drying and easier to apply than other paints. It is composed of plastic compounds such as vinyl acetate and acrylate which are dissolved in water. When the paint dries, the water evaporates and a thin film is left out on wall surface as a coat.

UNIT- 2: CEMENT & ADMIXTURES

Babylonians were perhaps the first to use clay as cementing material. In ancient times stones have been invariably used as a construction material with lime as the binder for construction of forts and defense structures. Egyptians have

used lime and gypsum as cementing materials in the famous Pyramids.

The calcareous rocks used by the Romans were either composed of limestones burned in Kilns or mixtures of limestones and puzzolanic materials (volcanic ash, tuff) combining into a hard concrete.

The natural cement is obtained by burning and crushing the stones containing clay, carbonate of lime (CaCO_3) and a little quantity of magnesia. The natural cement is brown in color and is also known as Roman cement.

The artificial cement was invented by a mason **Joseph Aspdin in England in 1824**. He took out a patent for this cement and called it Portland cement because it had resemblance in its color after setting, to a variety of sandstone which is found in Portland in England.

The manufacture of Portland cement was started in England around 1825.

Belgium and Germany started the same in 1855. America started the same in 1872 and India was installed in Tamil Nadu in 1904.

PROPERTIES OF CEMENT:

- It gives strength to the masonry works.
- It is an excellent binding material.
- It is easily workable
- It offers good resistance to the moisture
- It possesses a good plasticity.
- It hardens early.

COMPOSITION OF ORDINARY CEMENT/ PORTLAND CEMENT: The ordinary cement contains two basic ingredients namely, argillaceous (clay predominates) and calcareous (calcium carbonate predominates). A typical chemical analysis of an ordinary cement is as follows:

Ingredient	Oxide / composition	%	Range	Function
Lime	CaO	62	60– 65	Controls strength and soundness. Its deficiency reduces strength & setting time
Silica	SiO_2	22	17 – 25	Imparts strength. Excess cause slow setting
Alumina	Al_2O_3	5	3 – 8	Responsible for quick setting, if in excess, it lowers the strength / weakness the cement

Calcium sulphate	CaSO ₄	4	3 – 4	
Iron oxide	Fe ₂ O ₃	3	0.5 – 6	Gives colour, hardness & strength to the cement
Magnesia	MgO	2	0.5 – 4	Gives color, hardness. If in excess, it causes cracks in mortar.
Sulphur	SO ₃	1	1 – 2	A small amount of sulphur is useful in making sound cement. If it is in excess , it causes cement to become unsound
Alkalies	(Na ₂ O+K ₂ O)	1	0.1 – 0.4	These are residues and if in excess cause efflorescence and cracking

Excess in quantity of ingredients cause unsound, prolonging of setting time. However, the rate of setting of cement paste is controlled by regulating the ratio $\text{SiO}_2 / (\text{Al}_2\text{O}_3 + \text{Fe}_2\text{O}_3)$.

USES OF CEMENT: Cement is widely used in construction of various engineering structures. Following are various possible uses of cement:

- Cement mortar for masonry works
- Cement Concrete for laying floors, roofs, lintels, beams, stairs, pillars etc
- Construction of important engineering structures such as Bridges,

Culverts, Dams, Tunnels, storage Reservoirs; Docks etc

- Making Cement Pipes
- Manufacture of precast pipes, dust bins, fencing posts etc..

ORDINARY PORTLAND CEMENT: The artificial cement is obtained by burning at a very high temperature of a mixture of calcareous (limestone) and argillaceous (clay) materials. The calcined product is known as the CLINKER. A small quantity of gypsum is added to the clinker and it is then pulverized into very fine powder which is known as the CEMENT. This cement is also known as the *normal setting cement or ordinary cement*.

The Ordinary Portland Cement has been classified as 33 Grade (IS269: 1989); 43 Grade (IS 8112:1989) AND 53 Grade (IS 12669:1987). The physical requirements of all these three types of cement are almost same except for compressive strength and are as follows:

S.No	Physical requirement	Grade		
		33	43	53
1	Fineness	255	255	255
2	Soundness	10 mm	10 mm	10 mm
3	Setting time (minimum)	30 minutes	30	30
	Setting time (maximum)	600 minutes	600	600
4	Compressive Strength (MPa or Mega Pascals) not less than			
	72 hours (3 days)	16	23	27
	168 hours	22	33	37

	(7 days)			
	672 hours (28 days)	33	43	53

IS:10262 has classified the OPC grade-wise from A to F based on 28 day compressive strength as follows:

Category	Strength
A	32.5 – 37.5
B	37.5 – 42.5
C	42.5 – 47.5
D	47.5 – 52.5
E	52.5 – 57.5
F	57.5 – 62.5

--	--

MANUFACTURE OF CEMENT: Cement can be manufactured by using either from natural cement stones (in case of Roman cement, Puzzolana cement, Medina cement etc) or artificially (Portland cement) by using calcareous and argillaceous materials.

Calcareous (limestone, marl, chalk, marine shell) and argillaceous (clay, shale, slate etc) materials are used in the manufacture of Ordinary or Portland cement. From these materials, others like silica, iron-oxide, and small quantities of other chemicals such as Na, K, S are obtained during the process of manufacturing of cement. Cement can be manufactured either by dry process or wet process.

DRY PROCESS (Modern Technology) : This process is adopted when the raw materials are quite hard. The process is slow and the product is costly. The raw materials of limestone and clay are first reduced in size of about 25 mm in crushers. A dry air is then passed over these materials. These dried materials are then pulverized into fine powder separately in the ball mills.



Ball mill is a key equipment to grind the crushed materials, and the ball mill is widely used in powder-making production

All these materials are stored in hoppers / bins / silos and they are then mixed in correct proportions.

Fig: Hoppers /



Silos

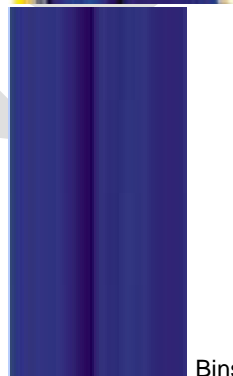

Bins

Hoppers, bins and silos are used in the aggregate, cement, chemical, mining and wastewater treatment industries for storing

many bulk materials.

Bins are used for storing smaller volumes of bulk materials.

Hoppers are similar to bins except with an open top. Silos are

typically designed for storing large volumes and are cylindrical in

shape with a cone.

		Storage capacities up to 10,000 cubic feet can easily be handled with hoppers, bins and silos.
--	--	--

The product obtained after calcination at a temperature of about 1400 – 1500°C in rotary kiln is called CLINKER.

The clinker is cooled rapidly to preserve the metastable compounds and their solid solutions and then ground in Tube Mills where 2 – 3 % of gypsum is added. The purpose of adding gypsum is to retard the setting of cement. Generally, cement is stored in bags of 50 kg. A flow diagram of dry process is shown in fig.



Rotary Kiln: The building material kiln is mainly used in cement industry, such as lime kiln, cement kiln.

The dry process has been modernized and it is widely used at present because of competition in production; lesser consumption of power; automatic proper temperature control ; advancement of instrumentation; computerization and quality.

FUNCTIONAL PRINCIPLE OF THE ROTARY KILN

- | | | |
|-------------------------------|--|-----------------------------------|
| 1 ROTATIVE COMBUSTION CHAMBER | 6 AUTOMATIC ASHES CHAMBER BURNER | 12 GAS TO POST-COMBUSTION CHAMBER |
| 2 FRONT HEAD | 7 ASHES CHAMBER | |
| 3 REAR HEAD | 9 WASTE FEEDER | |
| 4 START AND SUPPORTING BURNER | 10 SOLID, LIQUID, PASTY AND SLUDGY HAZARDOUS WASTE | |
| 5 PRIMARY AIR FAN | 11 UNLOADING ASHES COCHLEA | |

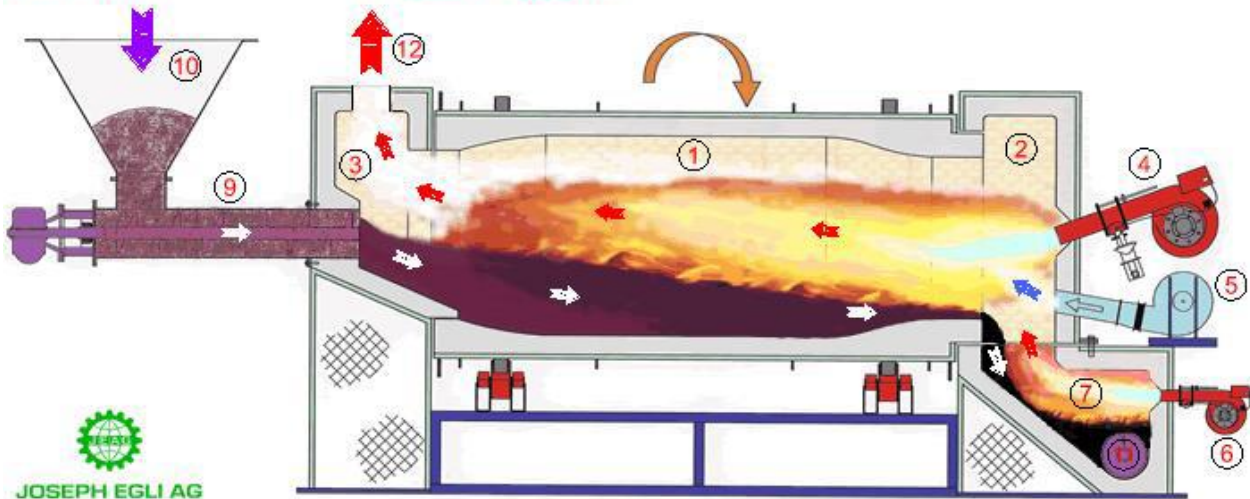

Flow diagram of manufacturing of cement

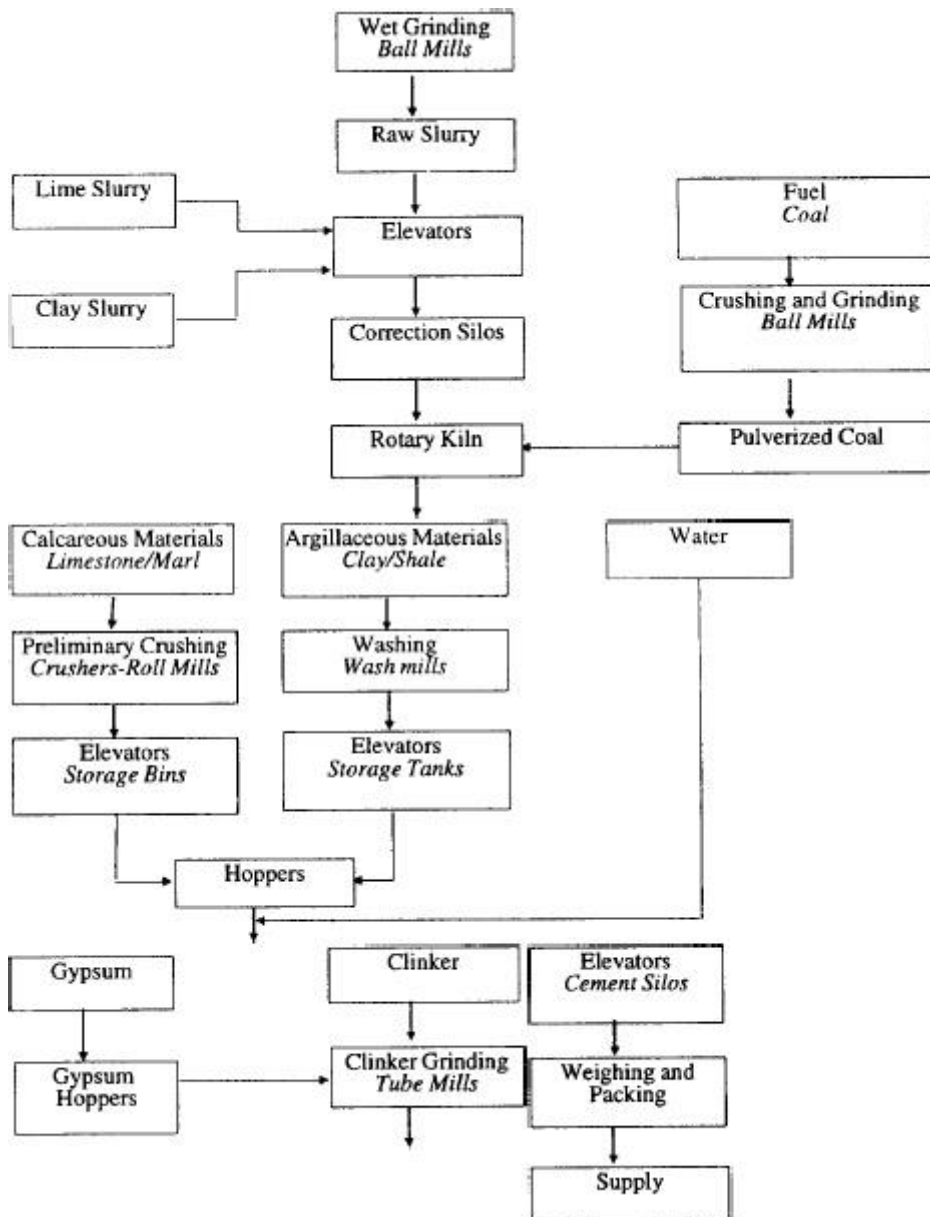

WET PROCESS (old technology) : Wet process was used for the manufacture of cement started from 1913 onwards and till early 1980. The operations involved in the wet process of cement manufacture are mixing; burning and grinding.

The crushed raw materials are fed into ball mill and a little water is added to make a thick paste. This paste, usually contain about 14% of moisture is dried and made ready for the feed of rotary kiln where it loses moisture and forms into lumps or nodules.. These are finally burned at 1500 – 1600°C where the nodules change to clinker at this temperature. Clinker is cooled and then ground in tube mills. While grinding the clinker, about 3% of gypsum is added. The cement is then stored in silos from where it is supplied.

During the operation of ball mill; the steel balls in it pulverize the raw materials which form a slurry with water. This slurry is passed to silos (storage tanks), where the proportioning of the compounds is adjusted to ensure desired chemical composition.

The chief advantages of the wet process are the low cost of grinding the raw materials, the accurate control of composition and homogeneity of the slurry, and the economical utilization of fuel.

Why gypsum is to be added during the manufacture of cement ???

The gypsum is the hydrated sulphate of calcium and its chemical composition is $\text{CaSO}_4 \cdot 2\text{H}_2\text{O}$. It contains 79.1% calcium sulphate and 20.9% water.

When gypsum is added to 205°C , its specific gravity increases from 2.3 to 2.95 due to loss of water. As a binding material, the gypsum quickly sets and hardens. It is soluble in HCl but insoluble in H_2SO_4 .

Gypsum has a number of valuable properties like bulk density, incombustibility, good absorbing capacity, good fire resistance, rapid drying etc.. Because of all these properties, gypsum is used in the manufacture of cement to increase its setting time.

PLASTER OF PARIS : Plaster of Paris is a calcium sulfate hemi-hydrate ($\text{CaSO}_4 \cdot \frac{1}{2} \text{H}_2\text{O}$) derived from gypsum by firing this mineral at relatively low temperature of $160 - 170^\circ\text{C}$ and then reducing it to powder. In ancient times, in Paris, all the walls of wooden houses were covered with plaster as protection against fire. Since then the plaster was named as Plaster of Paris.

POP powder is mixed with water to form a paste which releases heat and then hardens once dried under normal temperature. Unlike mortar and cement, plaster remains quite soft after drying, and can be easily rubbed or scratched with metal tools or even sandpaper. On heating, further upto a temperature of about 20°C , the entire water is driven off and the resulting product is known as the Gypsum Anhydrite.

FIELD TESTS & LAB TESTS FOR CEMENT: In engineering construction, the main qualifications of a cement are permanency of structure; strength and a rate of setting. To determine these qualifications, both physical and chemical tests are made, the former on account of importance more often than the other. However, following field tests are to be carried out to ascertain the quality of cement:

- The cement should feel smooth when touched in between fingers.
- If it is felt rough, it indicates adulteration with sand.
- If hand is inserted in a bag of cement, one should feel cool and not warm.
- If a small quantity of cement is thrown in a bucket of water, it should sink and should not float on the surface.
- The color of cement should be uniform and the typical cement color is grey.
- The cement should be free from any hard lumps. Such lumps are formed by the absorption of moisture from the atmosphere.

As a result of long experience the physical tests which have come into general use in determining the acceptability of cement are:

1. Soundness
2. Strength:
3. Consistency Test and
4. Fineness.

SOUNDNESS: It is an important test to assure the quality of cement since an unsound cement produces cracks, disintegration and leading to failure finally. The purpose of this test is to detect the presence of uncombined lime in cement. This test is ensured by limiting the quantities of free lime and magnesia ;which slake slowly causing change in volume of cement (known as unsound).

Some of the aggregates may be chemically unstable with certain chemical constituents react with alkalis in cement which may cause abnormal expansion and cracking of concrete.

Soundness of cement may be tested by *Le-Chatelier* method or by *autoclave* method. For OPC (Ordinary Portland Cement) ; RHC (Rapid Hardening Cement) ; LHC (Low Heat Cement) ; PPC (Portland Puzzolana Cement) ; soundness is limited to 10 mm whereas HAC (High Alumina Cement) ; SSC (Super Sulphate Cement) it should not exceed 5 mm.

STRENGTH: Cement is tested for Compressive and Tensile strength because the cement hydrates when water is added to it. So, the strength of mortar and concrete depends upon the type and nature of cement.

Hydration of cement: The chemical reaction between cement and water is known as hydration of cement

Conditions affecting strength:

- Cement is very strong at early stages if a high lime or high alumina content is present.
- Gypsum and Plaster of Paris in small percentages also tend to increase the strength slightly but when present in quantities more than 3%, these substances provide variable effects.
- The strength of cement is greatly also influenced by the degree of burning, the fineness of grinding.
- An under burnt cement is likely to be deficient in strength.

Compressive Strength.: Compressive Strength is the basic data required for mix design. By this test, the quality and quantity of concrete can be controlled and the degree of **adulteration** is checked.

The compressive strength at the end of 3 days, 7 days and 28 days are given in table and the results are expressed in N/mm²

Type	3 days	7 days	28 days
OPC	16.0	22.0	33.0
PPC	16.0	22.0	33.0
LHC	10.0	16.0	35.0
RHC	27.5	-	-

HAC	35.0	-	-
-----	------	---	---

Tensile Strength: Tensile Strength may be determined by Briquette Test method or by Split Tensile Strength Test.

The Tensile strength of cement affords quicker indications of defects in the cement. However, the test is also used for the determination of rapid hardening cement. The tensile strength at the end of 3 days and 7 days for OPC is 2.0 N / mm² and 2.5 N / mm² respectively.

(2.0 N / mm² = 20 kg / cm²) (2.5 N / mm² = 25 Kg / cm²)

Consistency Test: This is a test to estimate the quantity of mixing water to form a paste of normal consistency.



Vicat apparatus is used to determine the consistency

test. 300 gms of cement is mixed with 25% water. The

paste is filled in the mould of Vicat's apparatus and

the surface of the filled paste is smoothed and

leveled. A square needle 10 mm x 10 mm attached to

the plunger is then lowered gently over the cement

paste surface and is released quickly. The plunger

pierces the cement paste. The reading on the

attached scale is recorded. When the reading is 5 –

7 mm from the bottom of the mould, the amount

of water added is considered to be the

	correct percentage of water for normal consistency.
--	--

FINENESS: This test is carried out to check proper grinding of cement. In other words, the degree of fineness of cement is the measure of the mean size of the grains in it.

There are 3 methods for testing fineness:

- The Sieve method -- using 90 micron sieve
- The air permeability method (Lea Nurse and Blains method)
- The sedimentation method (Wagner Turbidimetre)

SIEVE METHOD: 100 gms of cement sample is taken and air set lumps if any, in the sample are broken with fingers. The sample is placed on a 90 micron sieve and continuously sieved for 15 minutes. The residue should not exceed the limits specified below:

OPC	10% of residue by weight
RHC	5% of residue by weight
PPC	5% of residue by weight

Air Permeability method: In this process, a cement sample of 20 mm height is placed in the Lea and Nurse apparatus and air pressure is applied. A manometer is connected to the top and bottom of the permeability apparatus and the pressure is so adjusted.

The specific surface (**Surface area** is the measure of how much exposed area a solid object has, expressed in square units) for various cements should be as specified in table:

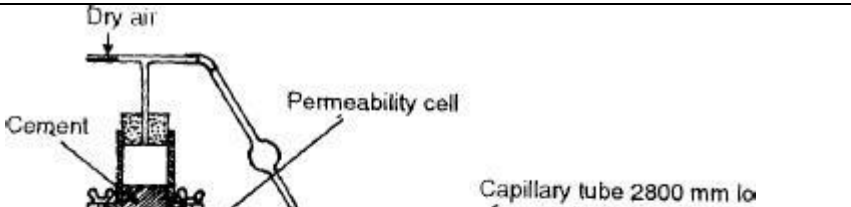
Type of cement	Specific surface not	
----------------	----------------------	--

	less than cm ² /gms
OPC	2250
RHC	3250
LHC	3250
PPC	3000
HAC	2250
SSC	4000

Fig: Permeability Apparatus

Wagner Turbidimetre method: This method is to be adopted to estimate the surface area of one gram of cement. The cement is dispersed uniformly in a rectangular glass tank filled with kerosene. Then, parallel light rays are passed through the solution which strike the sensitivity plate of a photoelectric cell. The turbidity of the solution at a given instant is measured by taking readings of the current generated by the cell. By recording the readings at regular intervals while the particles are falling in the solution, it is possible to secure information regarding the grading in surface area and in size of particle. Readings are expressed in sq cm per gms.

ADMIXTURES: Admixture is defined as a material, other than water, aggregates, cement, that is added to the concrete batch immediately before or during mixing. Admixtures change properties of the concrete such as colour, curing, temperature range and setting time.

Concrete is being used for wide varieties of purposes to make it suitable in different varieties of purposes to make it suitable in different conditions. Ordinary concrete may fail to exhibit the required quality performance or durability under different conditions. In such cases, admixture is used to modify the properties of ordinary concrete so as to make it more suitable for any situation.

Classification of admixtures as given by MR Rixom is:

- Plasticizers (Water Reducers)
- Superplasticizers (High Range Water Reducers)
- Retarders
- Accelerators
- Air entraining Admixtures
- Mineral Admixtures
- Chemical Admixtures
- Waterproofing Admixtures
- Gas forming Admixtures
- Colouring Admixtures

Plasticizers and Superplasticizers specifically developed in Japan and Germany

around 1970 and later on they were made popular in USA and Europe, Middle East. Unfortunately, the use of plasticizers and Superplasticizers have not become popular in India till recently (1985).

Plasticizers (Water Reducers): Concrete in different situations require different degree of workability. A high degree of workability is required in situations like deep beams, columns and beam junctions, pumping of concrete for considerable distances. One must remember that addition of excess water, will only improve the fluidity or the consistency but not the workability of concrete.

The easy method generally followed at the site in most of the conditions is to use extra water to overcome different situations which is unengineering practice. Today, the use of plasticizers help the difficult conditions for obtaining higher workability without using excess of water.

Superplasticizers (High Range Water Reducers): Superplasticizers constitute a relatively new category and improved version of plasticizer, the use of which was developed in Japan and Germany during 1960 and 1970 respectively.

Use of Superplasticizers permit the reduction of water to the extent upto 30% without reducing the workability. The use of superplasticizer is practiced for production of flowing, self levelling, self compacting and for the production of high strength and high performance concrete. Superplasticizers can produce: Same w/c (water cement ratio); same workability ; increased strength, homogeneous character etc.

Retarders: A retarder is an admixture that slows down the chemical process of hydration so that concrete remains plastic and workable for a longer time. The retarders are used in casting purposes. They are also used in grouting oil wells. Oil wells are sometimes taken upto a depth of about 6000 meter deep where the temperature may be about 200°C. The spacing between the steel tube and the wall of the well and to prevent the entry of gas or oil into other rock formations are to be sealed with cement grout. For all these works cement grout is required to be in mobile condition for about 3 to 4 hours even at that high temperature without getting set.

Accelerators: Accelerating admixtures are added to concrete to increase the rate of strength development in concrete to reduce the required period of curing. In the past one of the commonly used materials as an accelerator was calcium chloride. The recent studies have shown that calcium chloride is harmful for reinforced concrete.

Air entraining Admixtures: Air entrained concrete is made by mixing a small quantity of air entraining agent or by using air entraining cement. These air entraining agents modify the properties of plastic concrete regarding workability, segregation, finishing quality of concrete. Entrained air is intentionally incorporated, minute spherical bubbles of size ranging from 5 microns to 80 microns distributed evenly in the entire mass of concrete. Air entraining admixture is used to prevent frost scaling in concrete .

The following types of air entraining agents are used for making air entrained concrete:

- Natural wood resins
- Animal or vegetable fats and oils such as olive oil, stearic acid; oleic acid.
- Various wetting agents such as alkali salts
- Miscellaneous materials such as the sodium salts of petroleum

sulphonic acids, hydrogen peroxide and aluminium powder
The common air entraining agents are Vinsol resin, Darex, Airalon, Orvus, Teepol, Petrosan, Cheecol etc..
Air entrained concrete has been used in the construction of Hirakud dam, Koyna dam, Rihand dam etc.

Chemical admixtures: Chemical admixtures are added to concrete in very small amounts mainly for the entrainment of air, reduction of water or cement content, plasticization of fresh concrete mixtures, or control of setting time.

Mineral admixtures: Mineral admixtures (fly ash, silica fume [SF], and slags) are usually added to concrete in larger amounts to enhance the workability of fresh concrete; to improve resistance of concrete to thermal cracking and sulfate attack; and to enable a reduction in cement content.

USES:

A proper use of admixtures offers certain beneficial effects to concrete, including improved quality, acceleration or retardation of setting time, enhanced frost and sulfate resistance, control of strength development, improved workability, and enhanced finishability.

Fly Ash

Fly ashes are finely divided residue resulting from the combustion of ground or powdered coal. They are generally finer than cement and consist mainly of glassyspherical particles as well as residues of hematite and magnetite and some crystalline phases formed during cooling.

Use of fly ash in concrete started in the United States in the early 1930's.

In addition to economic and ecological benefits, the use of fly ash in concrete improves its workability, reduces segregation, bleeding, heat evolution and permeability, and enhances sulfate resistance.

One of the most important fields of application for fly ash is PCC pavement, where a large quantity of concrete is used and economy is an important factor in concrete pavement construction.

Mix Design: The substitution rate of fly ash for portland cement will vary depending upon the chemical composition of both the fly ash and the portland cement. The rate of substitution typically specified is a minimum of 1 to 1 ½ pounds of fly ash to 1 pound of cement. It should be noted that the amount of fine aggregate will have to be reduced to accommodate the additional volume of fly ash. This is due to fly ash being lighter than the cement.

The amount of substitution is also dependent on the chemical composition of the fly ash and the portland cement. Currently, States allow a maximum substitution in the range of 15 to 25 percent.

The two properties of fly ash that are of most concern are the carbon content and the fineness. Both of these properties will affect the air content and water demand of the concrete.

The finer the material the higher the water demand due to the increase in surface area. The finer material requires more air-entraining agent to give the mix the desired air content. The important thing to remember is uniformity.

If fly ash is uniform in size, the mix design can be adjusted to give a good uniform mix.

The carbon content, which is indicated by the loss of ignition, also affects the air entraining agents and reduces the entrained air for a given amount of air-entraining

agent.

UNIT- 4:

BUILDING COMPONENTS BUILDING SERVICES

CONTENTS

LINTELS Types of lintels Timber lintels

Stone Lintels

Brick Lintels

Steel Lintels

RCC Lintels

ARCHES Introduction

Terminology of arches

Classification of arches

STAIRCASES Terminology of staircases

Requirements of a good stair

Dimensions of a step

.... Classification of stairs.....Wooden stairs

RCC stairs

Foundations

BUILDING COMPONENTS

LINTELS and ARCHES: Openings are invariably left in the wall for the provision of doors, windows, cupboards, almirahs etc... These openings are bridged by the provision of either a lintel or an arch. Thus, both lintel as well as arch are structural members designed to support the loads..

A lintel is a sort of beam, which is placed across the opening. The width of a lintel is equal to the width of the wall and the ends of which are built into the wall. Lintels are simple and easy to construct. Lintels are classified into the following types according to the materials of the construction:

Timber Lintels: These are relatively costlier, structurally weak and vulnerable to fire. Sometimes timber lintels are strengthened by the provision of mild steel plates at their top and bottom, such lintels are called ***Fitched Lintels***.





TIMBER LINTEL

TIMBER LINTEL

Stone Lintels: These are common in usage where stone is abundantly available. Dressed stone lintels give good architectural appearance. Stone is very weak in tension and cracks develop if subjected to vibratory loads.



Stone lintel



Stone lintel

Brick Lintels: These are not structurally strong and they are used only when the opening is small and loads are light.



BRICK LINTEL

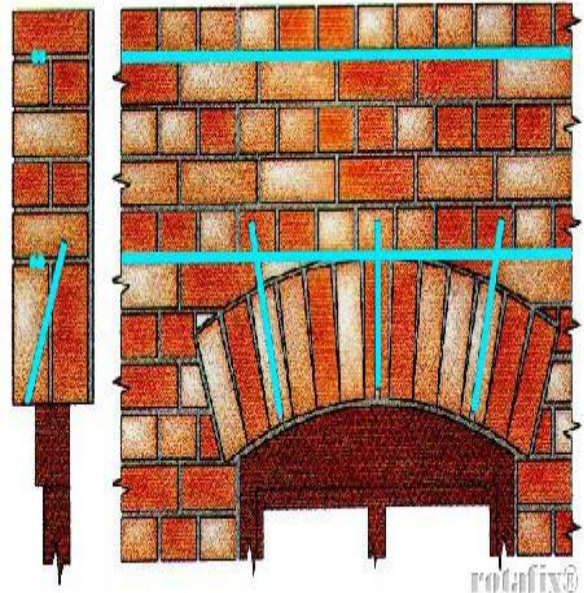

BRICK LINTEL

Steel Lintels: These are provided where the opening is large and the loads are heavy. It consists of steel channels either used singly or in combination of two or three units.



STEEL LINTEL

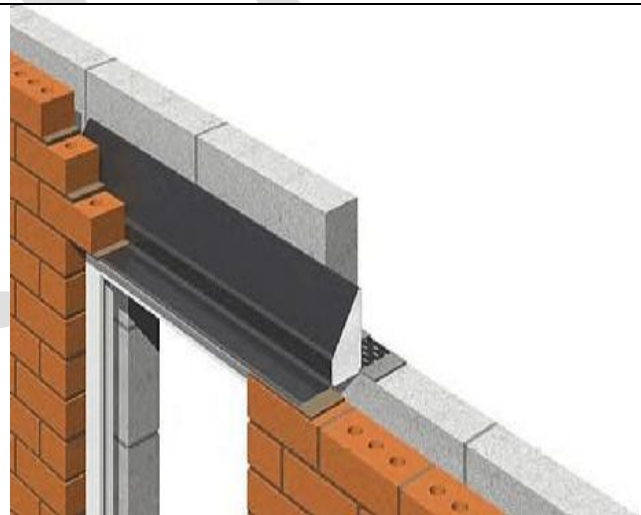

STEEL LINTEL

Reinforced Cement Concrete Lintels: Because of their strength, rigidity, fire resistance, economy and ease of construction, the RCC lintels are widely used. These can be used on any span. It is kept equal to the width of the wall. RCC lintels are also available as precast units.



RCC LINTEL



RCC LINTEL

Arches appeared as early as the 2nd millennium BC in [Mesopotamian](#) brick architecture and their systematic use started with the [Ancient Romans](#) who were [the first to apply the technique](#) to a wide range of structures.

An arch is an opening to support the weight of the wall or a load above it along with other superimposed loads.

A structure, especially one of masonry, forming the curved (an inverted U) pointed, or flat upper edge of an open space and supporting the weight above it, as in a bridge or doorway. However, arches are constructed where

1. Loads are heavy
2. Span is more
3. Strong abutment is available
4. Special architectural appearance is required.

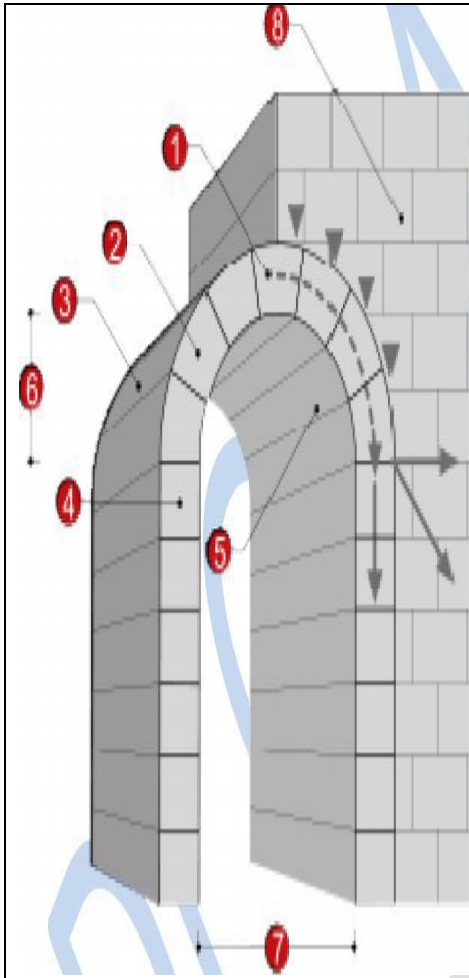

1. Keystone
2. Voussoir
3. Extrados
4. Impost
5. Intrados
6. Rise
7. span
8. Abutment

The following technical terms are used in arch

TERMS	
Abutment	This is the end support of an arch / The general mass of masonry that supports one end of the arch.
Extrados	A construction line denoting outer limit of the arch / It is the outer curve of an arch
Impost	The masonry piece that one end of the arch sits on
Intrados	This is the inner curve of an arch.

<p>Keystone</p>	<p>In stonework the keystone is a central Voussoir that is quite often decorated in some way. When the arch is being built it is always built up evenly from side to side and the last stone placed is the keystone</p>
<p>Voussoirs</p>	<p>The individual /wedge shaped masonry pieces that make up an arch.</p>

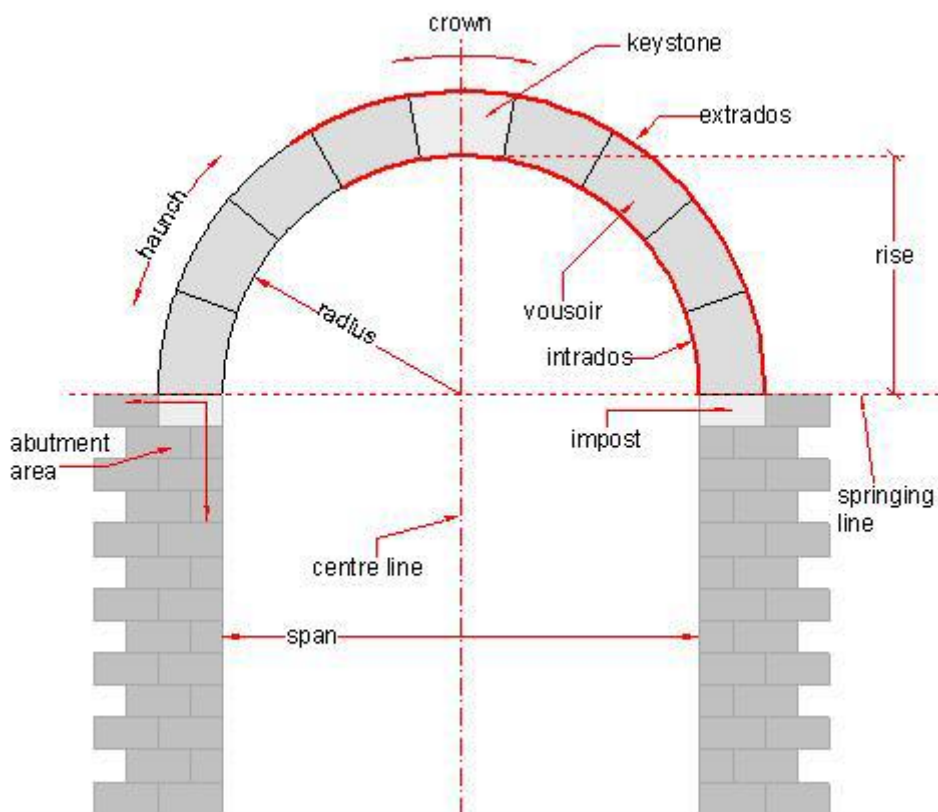

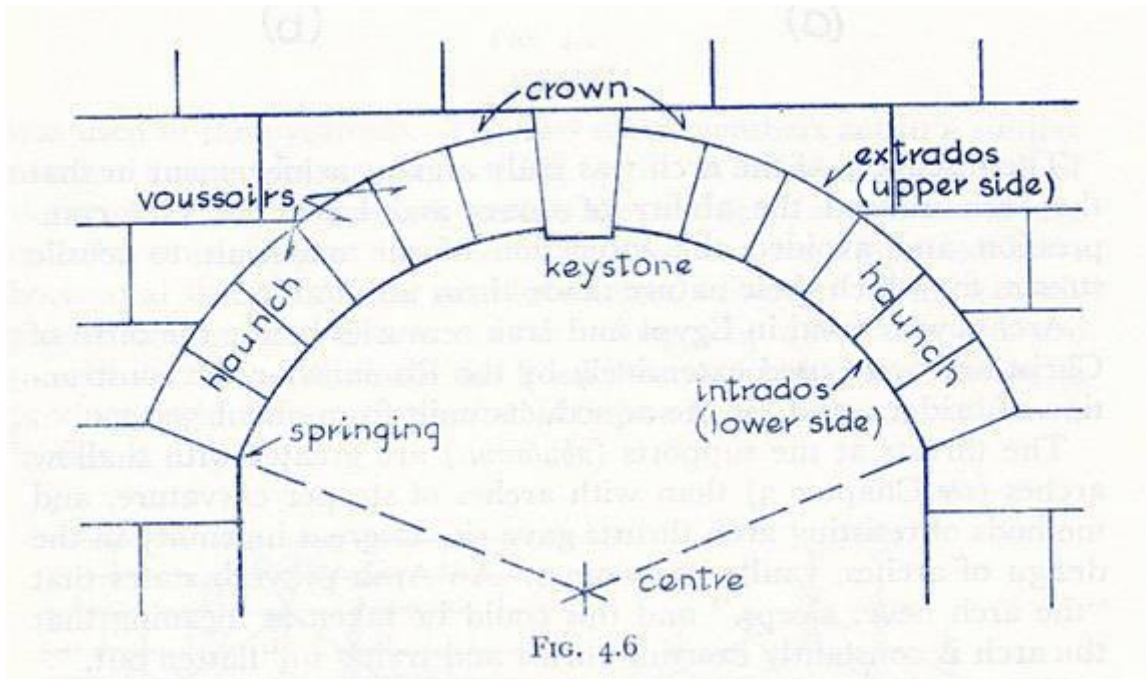

Arcade	It is a row of arches in continuation
Crown	The top section of a curved arch / It is the highest part of extrados.
Haunch:	The first few voussoirs up from the springing line / It is the lower half of the arch between the crown and skew back
Pier:	This is an intermediate support of an arcade.
Skewback	Inclined surface on the abutment
Soffit	It is a surface
Span	It is the horizontal distance between the supports
Spandril	This is a curved-triangular space formed between the extrados and the horizontal line through the crown.

Springing Line	A horizontal construction line denoting the starting of the curve in curved arches, or the bottom of a flat arch
Rise	Vertical distance between the highest point of the intrados and the springing line

Classification of Arches: An arch can be classified as

- According to Shape
- Based on Number of Centres
- Based on material and workmanship

Classification according to shape:

Flat Arch: A flat arch has usually the angle formed by skewbacks as 60° , thus forming an equilateral triangle with intrados as the base. The extrados is kept horizontal & flat. Flat arches are used for light loads and for spans upto 1.5 mts.

Segmental Arch: The centre of arch lies below the springing line or lies on the springing line.

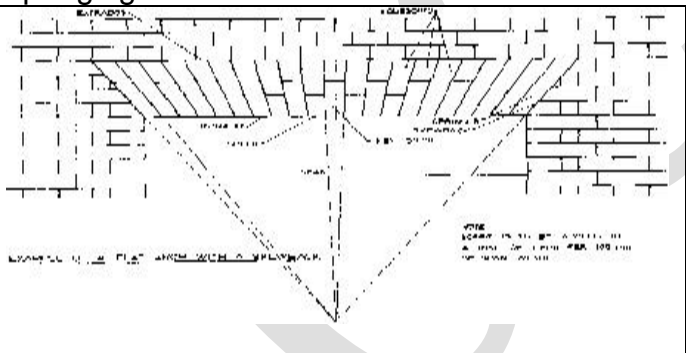
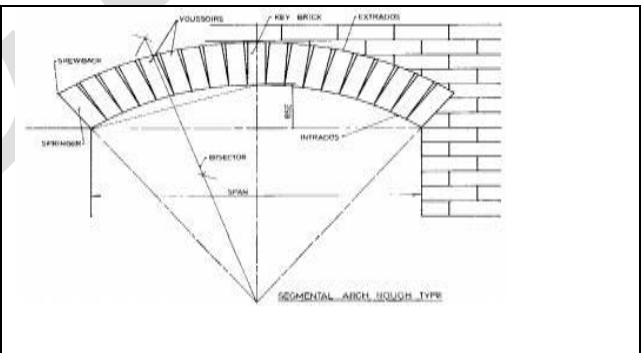
	
Flat arch	Segmental arch

Horse shoe arch: The arch has the shape of a horse shoe, which is more than a semi circle. Such type of arch is provided mainly from architectural considerations.

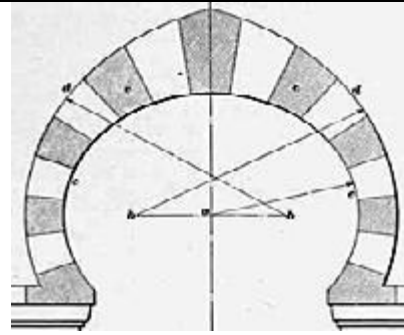

Horse shoe arch

Pointed arch: It consists of two arcs of circles meeting at the apex. The triangle formed may be either equilateral (all sides equal ie $ab = bc = ca$) which is also known as **GOTHIC arch** or isosceles (any two sides equal ie $ab=bc$ or $bc=ca$ or $ca=ab$) which is also called as **LANCET arch**.

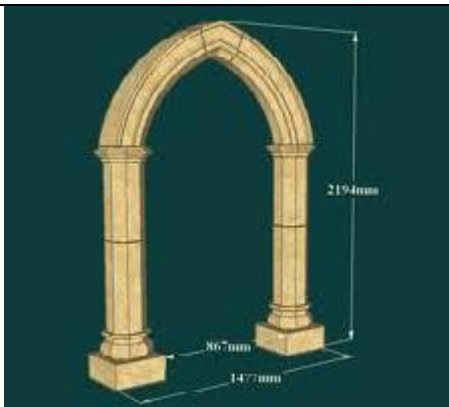

Gothic arch

Venetian arch: This is another form of pointed arch which has deeper depth at crown. It has four centers, all located on the springing line.



www.shutterstock.com · 52550221

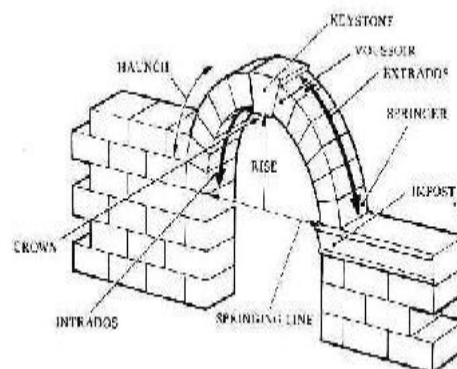

Venetian arch

Venetian arch

Florentine arch: This is similar to venetian arch except that the intrados is a semi- circle. The arch has, thus three centres, all located on the springing line.



Florentine
arch

Classification based on Number of centres The arches may be classified as:

One Centered arch: Segmented arches, flat arches, horse shoe arches, bulls eye arches come under this category



Bullseye arch



Elliptical arch

Two Centered arch: An arch whose intrados curve (inner curve of an arch is called as intrados curve) is described from two centres. Pointed arches such as Gothic and Lancet arches come under this category

Three Centered arch: An arch whose intrados curve is described from three centres. Elliptical arches come under this category.

Four Centered arch: A low elliptical or pointed arch; usually drawn from four centers is called as four centered arch. It has 4 centres. Venetian arch is a

typical example of this type. Another example is Tudor arch



www.shutterstock.com · 52550221

Tudor arch

Venetian arch

Five Centred arch: This type of arch, having five centres, gives a good semi elliptical shape

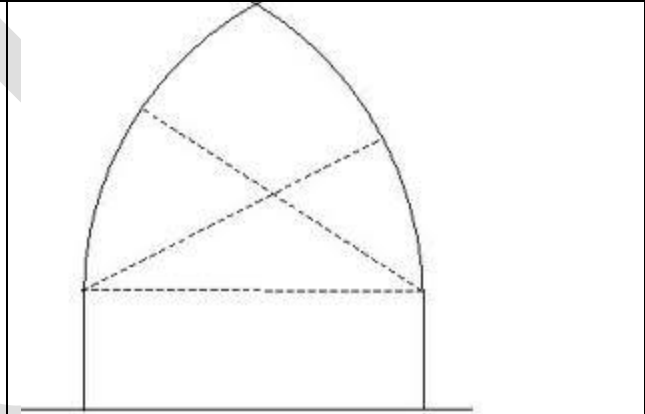

Five centred arch

Two centred arch

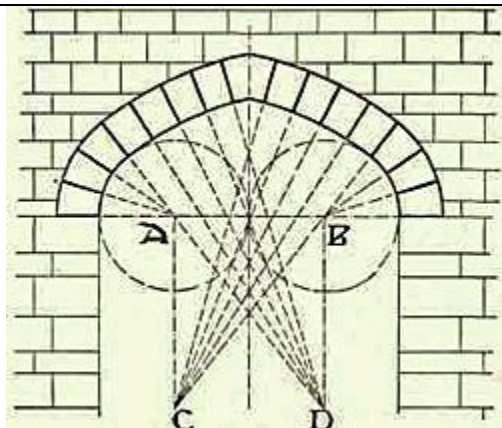
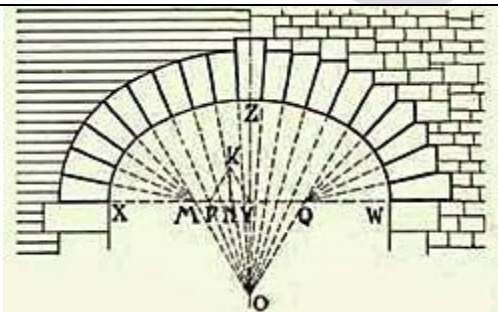

Three centred arch

Four centred arch

--	--

Classification based on Material and Workman ship

Stone Arches: Stones are mainly used in these arches.

Brick Arches: Quality of bricks are used in these arches.

Concrete Arches: Such arches are made from precast concrete blocks, each block being cast in the mould to the exact shape and size of Voussoirs. Cement concrete of 1:2:4 mix is usually used

GCCEFT

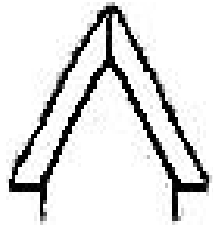

Triangular arch

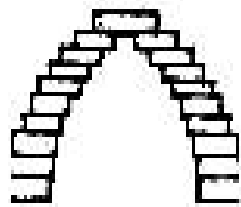

Corbel arch



French arch



Flat arch



Round arch

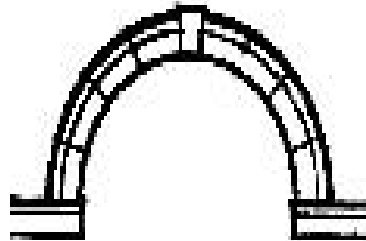

Roman arch

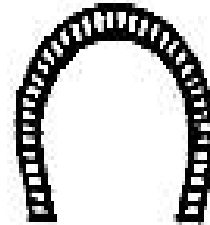

Horseshoe arch

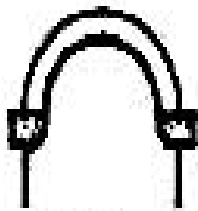

Bell arch

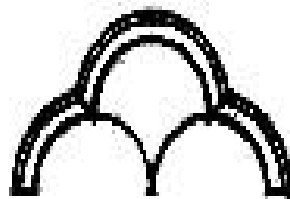

Trefoil arch (Gothic)

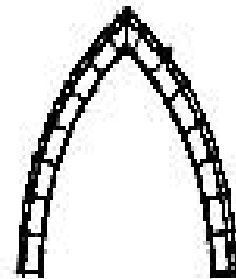

Lancet arch (Gothic)

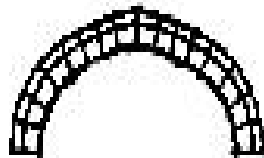

Tudor arch

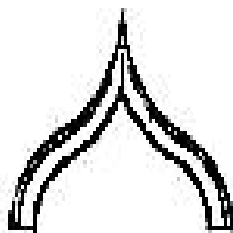

Ogee arch

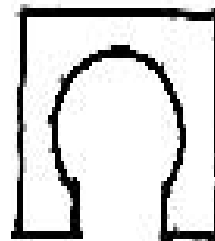

Syrian arch

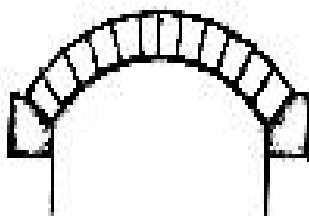

Segmental arch

STAIR CASES :

A stair is a set of steps leading from one floor to the other. The room or enclosure of the building, in which the stair is located is known as *stair case*. A staircase may be constructed around a central axis. Staircase is an important component of a building providing access to different floors and roof of the building. It consists of steps (stairs) and one or more slabs between the floor levels. Different types of staircases can be made by arranging

stairs and landing slabs. The main components of a staircase----stair, landing slabs and supporting beams or wall.

In a domestic building, the stairs should be centrally located to provide easy access to all the rooms whereas in public buildings, the stairs should be located near the entrance. In big buildings, there can be more than one stair.

Stairs may be constructed of timber, bricks, stones, Steel, RCC etc.. Apart from stairs, other means of vertical transportation between the floors of a building are Lifts; Ramps; Ladders; Escalators etc.. The Technical terms associated with the design and construction of stairs are defined below:

Step	Going	String
Tread	Flight	Winders
Flight	landing	Winders hand rail rails
Nosing	Newel Post	
Rise	Baluster	
Waist		

(a) Tread: The horizontal top portion of a step where foot rests is known as tread. The dimension ranges from 270 mm for residential buildings and factories to 300 mm for public buildings where large number of persons use the staircase.

(b) Nosing: In some cases the tread is projected outward to increase the space. This projection is designated as nosing

(c) Riser: The vertical distance between two successive steps is termed as riser. The dimension of the riser ranges from 150 mm for public buildings to 190 mm for residential buildings and factories.

(d) Waist: The thickness of the slab on which steps are made is known as waist. The depth (thickness) of the waist is the minimum thickness perpendicular to the soffit of the staircase. The steps of the staircase resting on waist-slab can be made of bricks or concrete.

(e) Going: Going is the horizontal projection between the first and the last riser of an inclined flight .

(f) Flight: The flight has two landings and one going.

(g) winders: Winders are steps located where a staircase turns and are narrower on the inside of the turn than they are on the outside.

Requirements of a good stair: A good stair should be designed so as to provide easy, quick and safe mode of approach between the floors. Following are the general requirements which a stair should fulfill.

Location: It should be located as to provide access to the occupants of the building. It should be so located that it is well lighted and ventilated directly from the exterior. It should be so located as to have approaches conveniently and

spacious.

Width of the Stair: It should be wide enough to carry the persons without inconvenience. In a domestic building, a 90 cm wide stair is sufficient while in public building, 1.5 to 1.8 mts width may be required.

Length of Flight: From comfort point of view, the number of steps are not more than 12 and not less than 3.

Pitch/Slope of stair: A comfortable slope should however be limited to 30° - 45°.

Private Staircase (Domestic)	=	42° Maximum.
Institutional & Assembly Stairs (Public)	=	33° Maximum.
Other (Semi Public)	=	38° Maximum.

Balustrade: Open stair should always be provide with balustrade to provide safety to the users. Wide open stair should have hand rail on both the sides.

Step Dimension: The dimensions of rise and going should provide comfort to the users. The proportion should also be comfortable to provide desirable pitch of the stair. The **dimensions of a step or Going and Risers are proportioned:**

For comfortable ascent and descent, the Rise and Going of a step should be well proportioned. However, the standards of Rise = 14 cms and Going = 30 cms are adopted. Usually, the combinations (in cms) for a comfortable steps are as follows :

$$(2 \times \text{Rise}) + (\text{Going}) = 60 \text{ cms}$$

$$(\text{Rise}) + (\text{Going}) = 40 \text{ to } 45 \text{ cms eg: } (15 + 28) \text{ or } (16 + 26) \text{ or } (17 + 24)$$

$$(\text{Rise}) \times (\text{Going}) = 400 \text{ to } 450 \text{ cms } (15 \times 28) \text{ or } 16 \times 26 \text{ or } (17 \times 24)$$

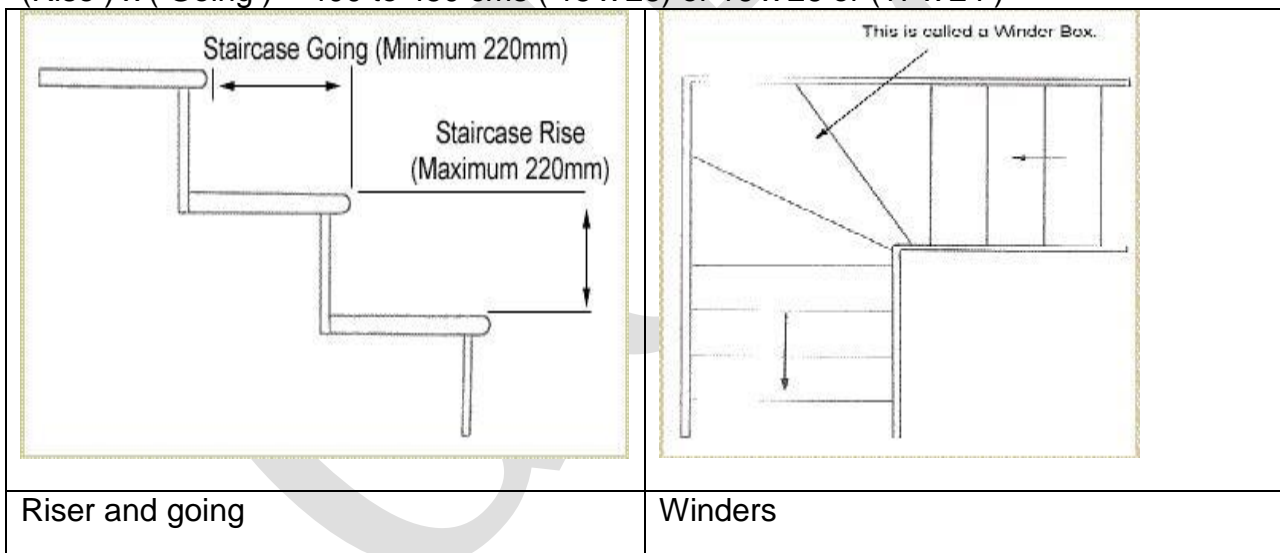

Materials: The materials used for the construction of stair should be having sufficient strength and fire resistance.

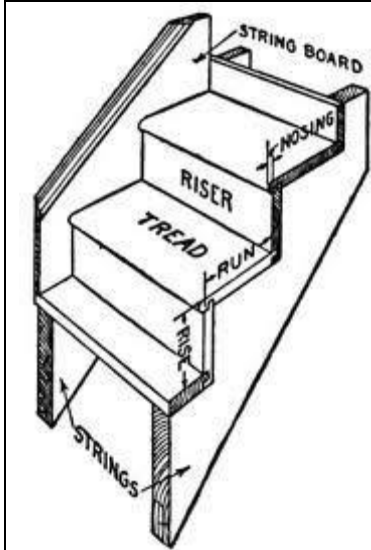

Stair case parts

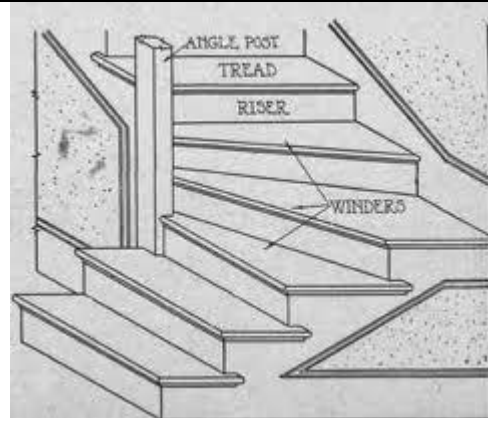

Stair case parts

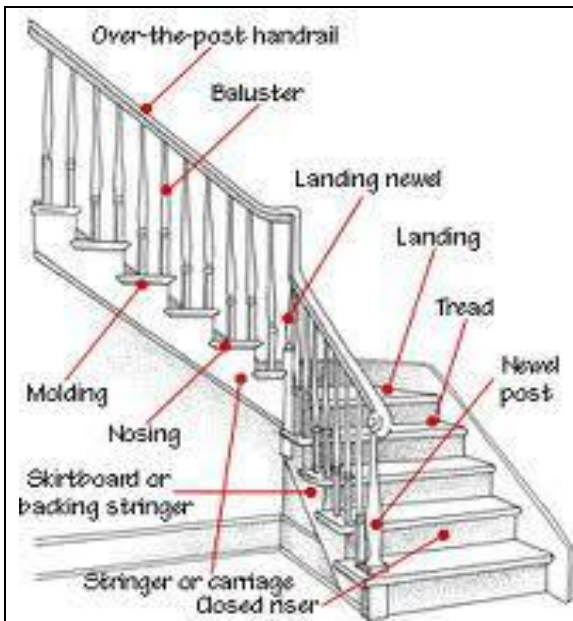

Stair case parts

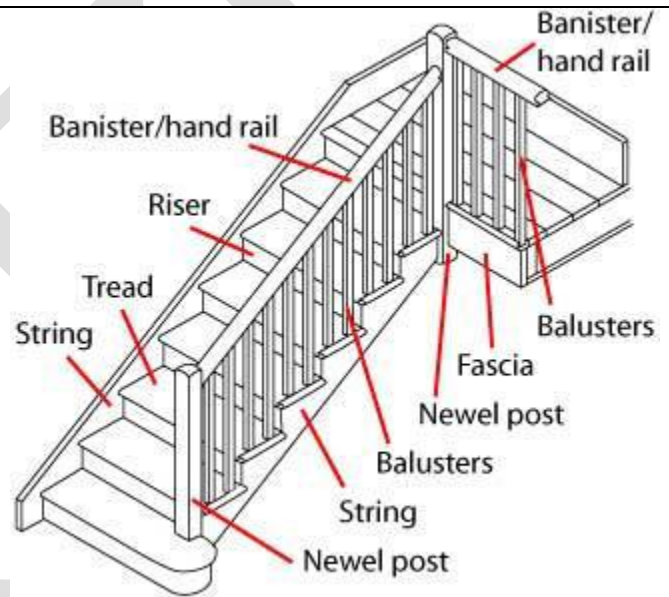

Stair case parts

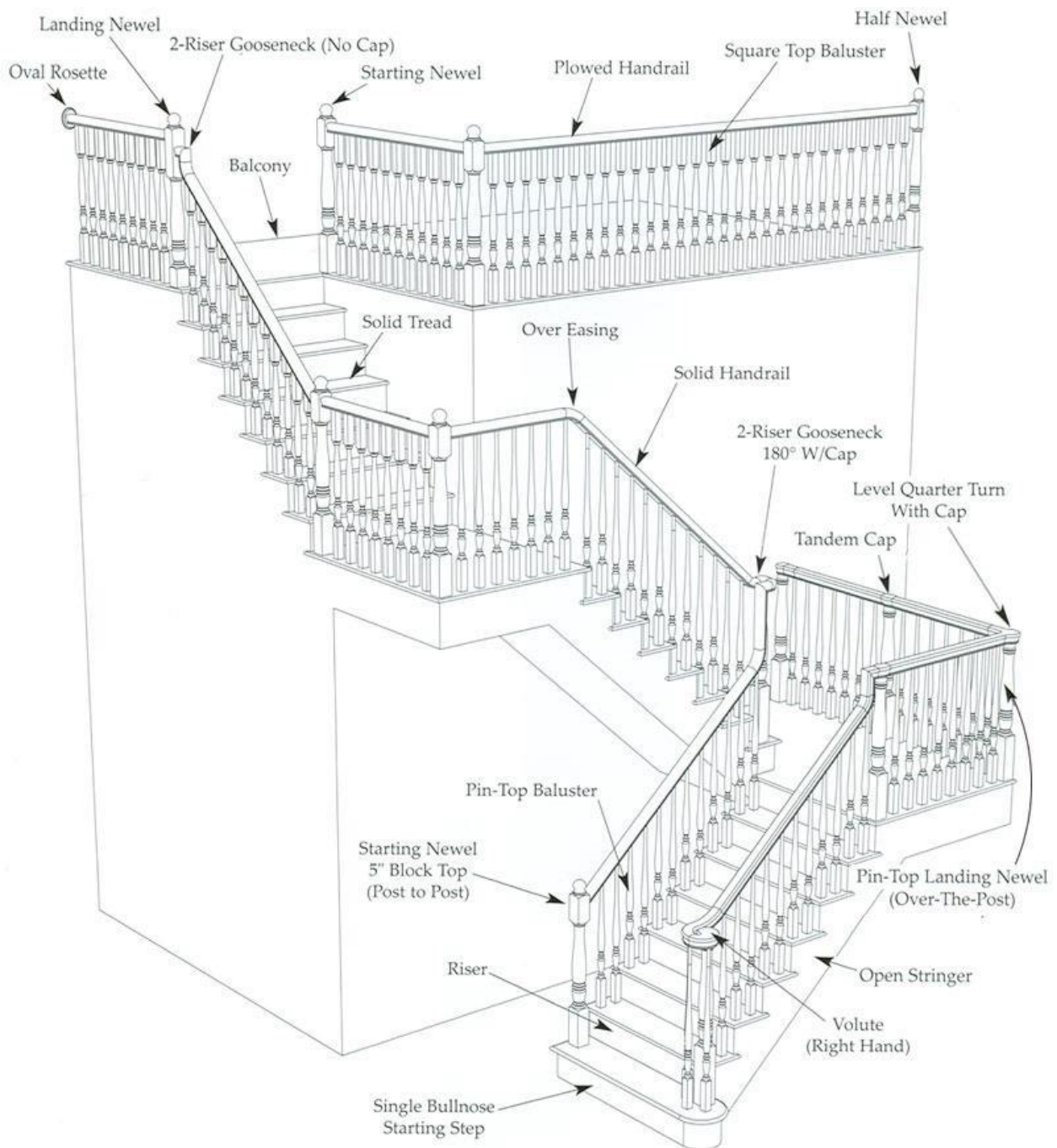

CLASSIFICATION OF STAIRS

Stairs can be classified in two broad heads:

(1) Straight stairs and (2) Turning stairs.

A) STRAIGHT STAIRS: This stair runs straight between the two floors. It is used for small houses where there are restrictions in available width. The stair may consist of either one single flight or more than one flight (usually two) with a landing.

		
Strait stair	Single flight staircase	Two flight staircase

B) TURNING STAIRS: These include:

- Quarter turn stairs..... Newel quarter turn stairs
- Geometrical quarter turn stairs.
- Half turn stairs Dog-legged stairs
- Open newel half turn stairs
- Geometrical half turn stairs.
- Bifurcated stairs
- Continuous stairs Circular stairs / spiral stairs
- Helical stairs.

1. Quarter turn stairs: A quarter turn stair is the one which changes its direction either to the left or to the right, the turn being affected either by introducing a quarter space landing or by providing WINDERS. Quarter turn stairs are:

a) Newel Quarter turn stairs: These stairs have the conspicuous (very noticeable) newel posts at the beginning and end of each flight. At the quarter turn, there may either be quarter space landing or there may be winders.

b) Geometrical Quarter turn stairs: In geometrical stairs, the stringer as well as the hand rail is continuous without Newel Post.



Newel Quarter turn stairs

Geometrical Quarter turn stairs

2. Half turn stairs: Half turn stair is the one which has its direction reversed or changed for 180°. These stairs are quite common. Dog legged stairs Open Newel Half turn stairs Geometrical half turn stair

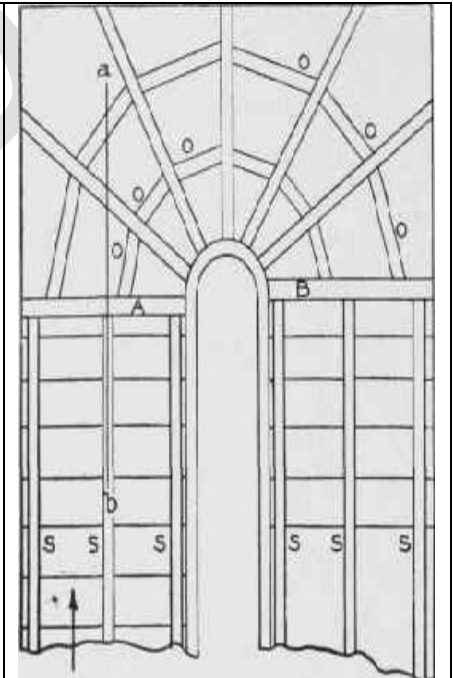
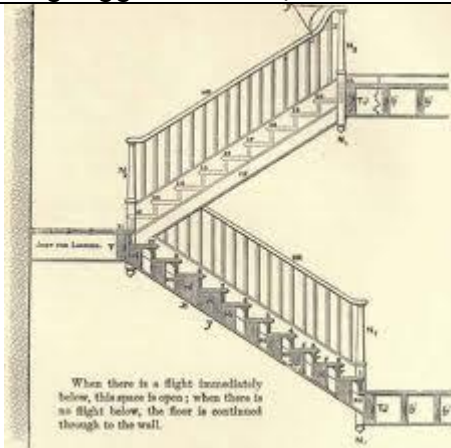

Dog legged stairs

Open Newel Half turn stairs

Geometrical half turn stair

a) Dog-Legged or Newel half turn stairs: Newel posts are provided at beginning and end of each flight in addition to half space landing and winders.

b) Open Newel half turn stair: It has a space or well between the outer strings. This is the only aspect in which it differs from the dog legged stair.

c) Geometrical Half turn stairs: The essential features of such stairs are that the stringers and the hand rails are continuous without Newel post. These may be either with half space landing or without landing.

3. Bifurcated stair: This type of stair is commonly used in public buildings at their entrance hall. The stair has a wider flight at the bottom, which bifurcates into two narrower flights, one turning to the left and the other to the right.



4. Continuous stairs: Continuous stairs are those which do neither have any landing nor any newel post. They are, therefore, geometrical in shape. Continuous stairs may be of the following types:

a) Circular stairs / spiral stairs : These are employed at a location where there are space limitations and such a stair is usually made either of RCC or metal. These are also provided at the back side of a building. **All the steps are winders.** The stair is therefore not comfortable.

b) Helical stair: Its structural design and construction is very complicated. It is made of RCC in which a large portion of steel is required to resist bending shear and torsion.

Spiral stair case
Spiral stair case
Spiral stair case
Helix stair case
Pitch line
Curved & Flared stair case



Spiral stair case



Spiral stair case



Spiral stair case



Helix stair case

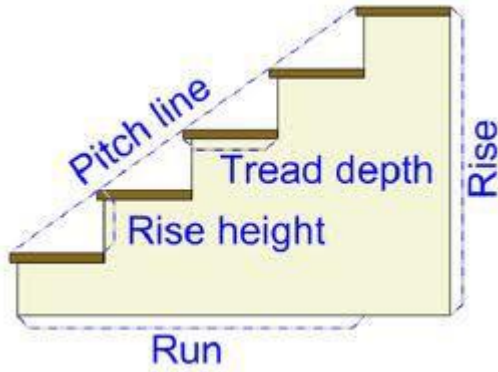

Pitch line



Curved & Flared stair case

WOODEN STAIRS (TIMBER STAIRS)

Wooden stairs are light in weight and easy to construct, but they have very poor fire resistance. However, timber can be made fire resistant by sir Abel's process. They are used for small rise residential buildings and unsuitable for high rise residential and public buildings. The timber used for the construction should be free from fugal decay and insect attack and should be well treated before use.

In timber stairs, the strings are the support for the stair and act as inclined beams between the floor and the landing. The thickness of strings may be 3 to 5 cms.

For additional support, a bearer / a carriage may be placed under the treads. The normal practice is to provide one bearer. For a 90 cm wide staircase, and an additional bearer for every 40 cm of width is provided.

Timber risers and treads are joined by means of nailed or screwed. Scotia blocks may be provided to improve the appearance of steps.

RCC STAIRS

RCC stairs are the one which are widely used for residential, public and industrial buildings. They are strong and fire resisting. Based on the direction of

span of the stair slab, concrete stairs may be divided into two categories:

Stairs with slab spanning horizontally: In this category, the slab is supported on one side by side wall and on the other side by a stringer beam.

INCOMPLETE..... REFER PAGE 325 OF PUNMIA

Stairs with slab spanning longitudinally: In this category, the slab is supported at bottom and top of the flight, and remain unsupported on the sides. Each flight of stair is continuous and is supported on beams at top and bottom. Dog legged stairs are typical example of this type.

The main reinforcement is provided parallel to the direction of flight and the distribution reinforcement is provided along the width of the slab. For wider stairs, sometimes a central stringer beam is provided between the end walls. The stringer is also known as T-beam.

FOUNDATIONS

A building usually consists of two basic components viz.. the super-structure and the sub-structure / Foundation.

The super-structure is a part of the building which is above the ground level and serve the purpose of its intend use. The substructure / foundation is the lower portion of the building, usually located below the ground level which transmits the load of the super structure to the sub-soil.

A foundation is therefore that part of the structure which is in direct contact with the ground to which the loads are transmitted. The basic functions of a foundation is:

- To transfer the live and dead loads of the building to the soil over a large enough area so that neither the soil nor the building will move.
- In areas where frost occurs, to prevent frost from moving the building.

Hence, the basic function of a foundation is to transmit the dead loads or superimposed loads from a building to the soil, on which the building rests.

Dead loads are the weight of the building materials and the soil surrounding the foundations.

Live loads include the weight of people, furniture, snow, rain, and wind. Wind may be a vertical force downward, a horizontal force, or an uplift force. A live load may also be exerted by water in the soil around the foundations. Wet soil exerts much more force than dry soil. Frozen soil exerts much more force than wet soil. The soil which is located immediately below the base of the foundation is called the sub-soil / foundation soil, while the lower most portion of the foundation which is in direct contact with the sub-soil is called the Footing. or the bottom part of a **foundation** is called a **footing**

Weak sub-soils which are made up ground; shrinkable / expansive soils such as clay; frost action; movement of ground water; excessive vibrations due to traffic and machinery; slow consolidation of saturated clays; slipping of strata on sloping areas are to be taken into account while designing the foundations.

Different types of foundations: Foundations may be broadly classified as:

Shallow Foundations: A foundation is shallow if its depth is equal to or less than its width.

Deep Foundations: A foundation is deep if its depth is equal to or greater than its width.

A) From the point of view of design, the various types of shallow foundations are:

Spread Footing: Spread footings are those which spread the load of a wall or column over a large area. Spread footings may be of the following kinds:

(i) Single Footing for a column: In this type of footing, the loaded area ($b \times b$) of the column spread to the size ($B \times B$) through a single spread. The base is generally made of concrete.

(ii) Stepped Footing for a column: This type of footing is designed for a heavily loaded column which requires greater spread. The base of the column is made of concrete.

(iii) Sloped Footing for a column: In this case, the concrete base does not have uniform thickness but is made sloped with greater thickness where it is required.

(iv) Wall footing without step consisting of concrete base without any steps.

(v) Wall footing with steps consisting of concrete base with steps as shown in the figure..

Combined footings: A spread footing which supports two or more columns is termed as combined footing. The combined footings may be

(i) Rectangular combined footing: Columns will be rectangular in shape if they carry equal loads. The design should be done in such a way that centre of gravity of column loads coincide with the centroid of the footing area.

(ii) Trapezoidal combined footing: If the columns carry unequal loads, the footing is of trapezoidal shape as shown.

(iii) Combined column-cum-wall footings: Sometimes it may be required to provide a combined footing for columns and a wall. Rectangular and trapezoidal footings are to be adopted when the columns carry equal loads and columns carry unequal loads respectively as shown in the figure.

Strap Footing: If the independent footings of two columns are connected by a beam, it is called strap footing. A strap footing may be used where the distance between the columns is so great.

In this case, the column A is so near to an existing wall and the strap beam does not remain in contact with soil and thus does not transfer any pressure to the soil.

Mat Footing / Raft Footing: A raft or mat is combined footing that covers the entire area beneath a structure and supports all the walls and columns.

When the building loads are heavy, the use of spread footings would cover more than one half the area and is more economical to use mat or raft foundation.

A true raft / mat is a flat concrete slab with uniform thickness throughout the area. This is adopted when the column spacing is small and column loads are relatively small.

B) From the point of view of design, the various types of deep foundations are:

(i) Rectangular or Square footing comes under the category of deep foundations, when the depth of the foundation is greater than the width of the footing.

(ii) Pile foundation: Pile foundation is that in which the loads are taken by means of vertical members which may be of steel or concrete. Pile foundations may be adopted instead of a raft foundation when the loading is uneven or where the footing is uneconomical or where the sub-soil water pumping would be too costly. Piles used for building foundation may be of 4 types

- I) End bearing pile
- II) Friction pile
- III) Combined end bearing and friction pile
- IV) Compaction pile

(iii) Pier Foundation: A pier foundation consists of a cylindrical column of large diameter to support and transfer large super imposed loads to the below strata. Pier foundations transfer the load through bearing only. Generally, pier foundation is shallower in depths than the pile foundation. Pier foundation is preferred in a location where the top strata consists of decomposed rock overlying a sheet rock.

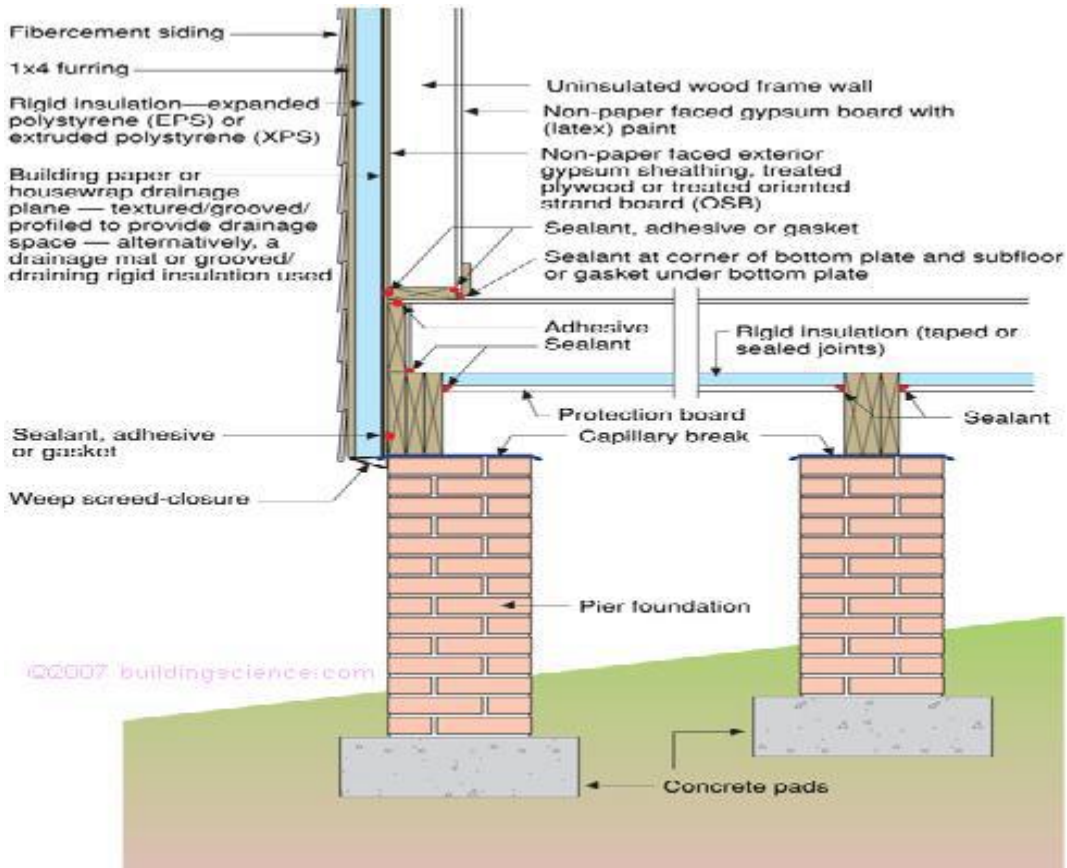

(iv) Well Foundation (or Caissons: Well foundations are box like structure, circular or rectangular in shape which are sunk from the surface of either land or water to the desired depth. They are much large in diameter than the pier foundations. Caisson foundations are used for major foundation works such as :

- Bridge piers and abutments in rivers.
- Wharves (A landing place or pier where ships may tie up and load or unload), & Docks
- Structures related for shore protections.
- For pump houses etc.....

Well foundations are hollow (inside) which may be filled with sand and are plugged at the bottom. The load is transferred through the perimeter wall called steining..

BUILDING SERVICES

PLUMBING SERVICES (WATER DISTRIBUTION, SANITARY)



How best a building might have been planned and built; it is incomplete till adequate building services are not provided to it. Building / Plumbing services include:

- Water distribution system
- Sanitary fittings and
- Effective drainage system

Sufficient quantity of water is provided to the building for the needs such as drinking, bathing, washing of cloths and washing of floors. More quantity of water is used through sanitary fittings like water closets, wash basins, sinks, bath rooms etc.. After use of whole water, some quantity of water gets polluted and has to be drained off through the underground drains. In addition, telephone services and electric fittings are also come under the preview of building services.

WATER DISTRIBUTION SYSTEM / WATER SUPPLY:

Water supply to water closets; bath rooms, wash basins, kitchens etc of a building is provided through water supply pipes from municipal water mains which run along the streets. Over head water storage tanks are also connected to municipal mains through pipes with the help of ferrule. Ferrule Water closet

	
<p>Ferrule</p>	<p>Water closet</p>

Requirement of water for residences should be assumed as 135 liters per head per day whereas the requirement varies from 45 to 70 litres per day for schools / restaurants / offices per seat.

For water supply to the buildings / offices, always galvanized iron pipe of 15 mm dia is used. From municipal mains to house, the pipe line may be

buried underground by arranging elbows, nipples, clamps, sockets, bends, bib-taps, check nut/ unions, gate valves/ball valves etc.. and finally connected to bath rooms, kitchens, wash basins, sinks. A water meter is also provided to the municipal mains at the entry level of water mains to a building.

SANITARY LINES & FITTINGS:

For collection of water, various types of sanitary fittings are required and to be fitted in the building. All these fittings should be as far as possible be fitted against an external wall. Following are some of the examples for sanitary fittings:

WASH BASINS: These are used for washing hands, tooth brushing, face washing etc and usually fixed that the height from the floor to the top of the basin is 78.5 cm.

SINKS: These are used cleaning of utensils in kitchens or glassware items in laboratories. Sinks are rectangular basins made from glazed earthen ware or stone-ware with flat bottom and all their internal angles are made round for easy cleaning.. Sinks are fixed in such a way that height of the top of the sink from floor is 90 cm.

BATH TUBS: These are made from enameled iron, plastic, Cast Iron, porcelain, marble. Normal dimensions of bath tubs are as follows:

- Length..... 1.7 - 1.85 mts
- Width..... 70 – 75 cms
- Overall height 58 – 60 cm

The bath tub is provided with a tap to fill it with water and an outlet to drain the water. In some tubs two taps are provided, one for hot and another for cold water supply. Bath tub should also be provided with one over-flow pipe to take away excessive spilling water.

WATER CLOSET (W.C.): It is used to receive human excreta directly from persons using it. The appliance is connected to the porcelain pipe by means of a trap. The water closets may be Indian type or European type. Both these WC's have an arrangement of flushing the discharged excreta by the persons with the help of water.



Indian W C



European W C

--	--

URINAL SYSTEMS: Urinal systems are used to discharge urine. They may be bowl type or stack type.. Urinals are discharged into the pipe through a nehani trap. Urinals should be designed to allow a minimum clear width of 60 cm between partition. The number of stack urinals draining into any one outlet should preferably be not more than 5 in case of public buildings.

	
<p>Bowl type urinals</p>	<p>Stack type urinals</p>

DRAINAGE SYSTEM: Drainage of a locality can be divided into public drainage and private drainage systems.

Under public drainage category, municipal sewers/drains are laid along the roads and are properly maintained by municipal / corporation authorities. Houses and buildings are constructed along both the sides of the roads by laying own sewer lines inside the house / building premises under the category of private drainage system. These sewer lines collect sewage / waste water from bathrooms, kitchens, water closets etc fitted in the building and convey it to the municipal sewers.

So, the system of sewer lines or drains laid in the premises of a building is called the house drainage.

Principles of house drainage:

- House sewers / drains should be laid as far as possible by the side of a building rather than below the building..
- The size of drain should be adequate for maximum discharge from the house.
- Drains should be laid at proper gradient so that the lowest level of the building may drain in it.

- Drain should be laid on good foundation and protected against external loads.
- As far as possible, drains should be laid in straight lines with successive inspection chambers.
- The house drain should be connected to the public sewer line which is always lower than the level of house sewer else, the flow in reverse direction may take place.

VENTILATIONS AND AIR-CONDITIONING OF BUILDINGS:

The process

of supplying fresh air and removing contaminated air by natural / mechanical process is termed as **ventilation**. To provide excellent conditions to live and work air movement, temperature, humidity conditions etc are important. The simultaneous control of temperature, humidity, air motion and air purity is known as air-conditioning.

SYSTEMS OF VENTILLATION: A good ventilating system should fulfill the following requirements:

- It should admit required amount of fresh air in the room.
- All the corners of the room should get proper ventilation.
- Desired humidity should be maintained.
- Effective temperature should be maintained
- The ventilating air should be free from impurities such as dust, odour etc

The systems of ventilation may be divided into two categories:

NATURAL VENTILATION: Natural system of ventilation is considered suitable for small houses and not for big buildings such as government offices, assembly halls, theatres, auditoriums and factories.

This natural ventilation system largely depends upon the scientific location of doors, windows, ventilators and other openings. Fresh air inside the building is cool and heavy. After sometime, the air becomes hot and lifted up in due course of time. The heated air is driven out through ventilators provided near the ceiling. For proper ventilation the top of this opening area should be not more than 45 cm below the ceiling.

Fresh air again comes in the building gets lifted up by heating and again escapes through openings provided near the ceiling. This effect cause flow of wind in upward direction and is known as **stack effect**.

General considerations for natural ventilation:

- Inlet openings should be located that all parts of the room are uniformly ventilated.
- Inlet openings should not be obstructed by trees, partitions, adjoining buildings etc.
- Outlet openings (ventilators) should be located near the ceiling.
- Outlet openings should be just opposite to inlets. This ensures better cross-ventilation.
- More height of the room gives better ventilation due to stack effect.
- If wind direction is variable , then openings should be provided in all the walls.

- In sloping or pitched roofs, ventilators are to be fixed at the ridge.

MECHANICAL VENTILATION: The system of ventilation in which some mechanical arrangements are made to provide adequate ventilation in the room is termed as mechanical ventilation.

Though the mechanical ventilation provides better comfortable conditions than natural ventilation, it is costlier method but it results in considerable increase in the efficiency of the persons working under such conditions. Mechanical ventilation can be classified broadly under the following headings:

(a) Extract or exhaust system: By fixing the blowers / fans, fresh air flow inside the room can be maintained.

(b) Supply or plenum system: Fresh air is forced with the help of input fans or blowers into the room and polluted air is allowed to leave the room by itself. The fresh air may be cooled or heated where required by installing cooling and or heating systems at the inlets. In this case, better control on humidity and temperature of incoming air can be exercised.

(c) Balanced system: This system uses fans to supply air. In this case entry of hot air is prevented by closing the doors or openings.

(d) Air conditioning: The simultaneous control of temperature, humidity, air motion and air purity is known as air-conditioning.

AIR CONDITIONING is one type of mechanical arrangement. This process consists of conditioning air w. r. t. humidity, temperature, odour, bacteria content, dust content and air movement so that comfortable conditions are maintained inside the room.

Types of air-conditionings:

- Comfort air-conditioning creates such conditions of the air inside the room, as would give maximum human comfort.
- Industrial air-conditioning creates and maintains the air to the needs of the industry during the material processing, manufacturing process, storage etc.
- Summer air-conditioning cools and control the inside temperature of the room.
- Winter air-conditioning is just the reverse of summer air-conditioning.
- Composite air-conditioning required to be done for the whole year irrespective of the temperature variation.

Principles of air-conditioning:

The temperature range which is liked by majority of the people is called the comfortable zone. A temperature of 21°C to 22.5°C is regarded as most likely comfort temperature in a room.

The air movement or velocity of air is important factor in air-conditioning. The velocity of air should be between 6 to 9 mts per minutue. It is remembered that the increase in air velocity decreases the inside effective temperature.

Humidity control of air is also important. An average value of relative humidity between 40 – 60% is considered desirable.

ROOM AIR-CONDITIONERS: These are self-contained air-conditioning units comprising a compressor, evaporator fan, and air-cooled condenser. This unit is used for single rooms having limited occupancy. These are suited for bed rooms, office cabins, hotel rooms and hospitals. Room air-conditioners are available in the normal range of 1.0; 1.5; 3.0, 4.5 tons capacity.

CENTRAL SYSTEM OF AIR-conditioning: In this system, various processes such as filtering; cooling or heating; humidification etc are all installed at a central place and conditioned air is distributed in all the parts of the building through system of ducts. This system is economical than other systems and better control on conditions inside the hall can be maintained.. However, this system requires an elaborate system of ducts which occupy considerable space.

ACOUSTICS

Acoustics is a science of sound that deals with the origin and propagation of sound waves. Hence, vibrations cause sound waves.

Vibrations causing sound, develop series of compressions and refractions in the medium and cause waves. These waves propagates the sound in all the directions from the source. Medium through which sound waves travel may be in solid, liquid or gaseous state. Sound waves cannot travel in vacuum as there is no medium for sound waves to travel. The speed with which sound waves travel through the medium, is known as *velocity of sound*.

Acoustics is used as a knowledge for the design and construction of theatres, cinemas etc with proper acoustical conditions.

For obtaining better acoustical conditions, some materials which could absorb all excess of sound energy are required to be incorporated on the surfaces of the room. Such materials are known as *sound absorbing materials*.

Sound absorbing material should be water-proof, fire-proof, quite strong ; good looking and economical in construction and maintenance. Sound absorbing capacity of the materials depends on the thickness, density,

softness and porosity of the materials. Less density, more thickness, and more of softness of the materials are the favourable properties for any sound absorbing material. Some of the sound absorbing materials are:

Straw board with 12 mm thickness has sound absorption coefficient of 0.30.



Pulp boards are quite cheap and can be fixed by ordinary paneling. Its coefficient of absorption is 0.17.

Acoustic plaster with 20 mm thick having density of 0.11 gm / cm³ has sound absorbing coefficient of 0.3 at 500 cycles / sec. It is also known as fibrous plaster.

Perforated plywood has the absorption coefficient value may be as high as 0.95 when made with mineral wool and cement asbestos

Wood wool boards with 2.5 cm thick has its absorption coefficient is 0.20

Quilts and mats are made from wool or glass wool and are mostly used as sound absorbing materials.

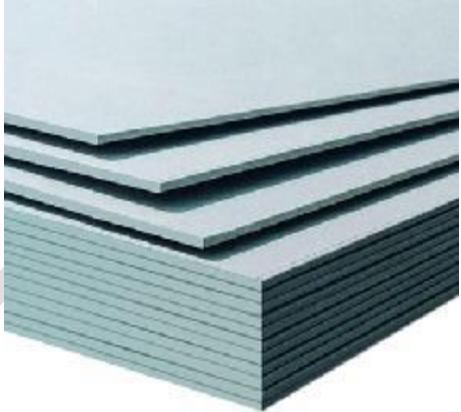
		
Straw board	Pulp material	Acoustic plaster board

	
Quilts and mats	Wood wool

FACTORS TO BE CONSIDERED IN THE ACOUSTIC DESIGN OF A HALL:

Volume: The volume of the hall should be in a relation to the intensity of the sound likely to be produced in the hall and also on the capacity of the hall. In fixing the volume of the hall, its height plays a more significant role than length and breadth.

Eg: cinema halls ---- 3.7 to 4.2 cum per seat

Shape: Echoes and other defects generated due to sound wave reflections can be eliminated by scientifically shaping the hall. Concave walls are considered not good from the acoustic point of view due to the formation of focal points where sound waves get concentrated and thus acoustic behavior of the hall is disturbed. Plain walls are considered good but convex walls are considered excellent. Height of the ceiling should be about $\frac{1}{2}$ to $\frac{2}{3}$ rd of the width of the hall. However, the radius of curvature of the ceiling should be studied properly.

FIG: 21.13 OF PAGE 21.46 MAHABOOB BASHA

Sound Absorption material: while making the selection of sound absorbing material, cost, durability, appearance, fire resisting properties etc should be considered along with about absorbing properties..

UNIT: 5

MASONRY AND FINISHINGS, FORM WORK

MASONRY .. Introduction..

Definitions of terms

BRICK MASONRY Types of bricks

Classes of bricks

Bonds in brick works

FINISHERSPlastering Tools for plastering

Methods of plastering

Types of mortars

Number of coats of plaster

Materials used in plastering

Pointing

Painting

Claddings

Tiles

MASONRY AND FINISHINGS

Masonry is defined as the art of construction in which building units such as clay bricks, sand, lime, stones, pre-cast hollow concrete blocks, concrete slabs, combination of some of these building units etc are arranged systematically and bonded together to form a homogeneous mass in such a manner that they can with stand the loads.



Masonry can be classified into the following categories.



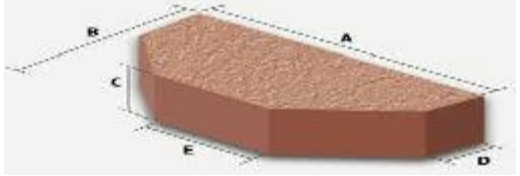

1. Stone masonry
2. Brick masonry
3. Hollow block concrete masonry
4. Reinforced masonry
5. Composite masonry

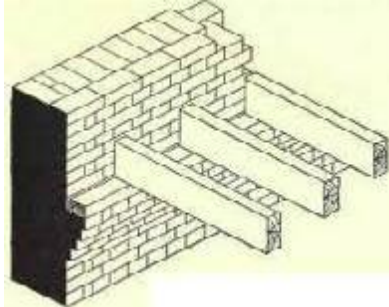
These can be further sub-divided into various types depending upon workmanship and type of materials used.

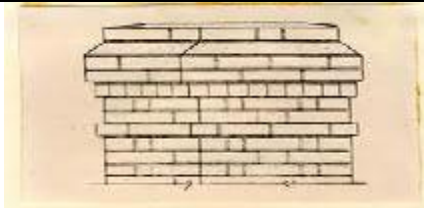
Definitions of terms:

Air brick	A brick with perforations to allow the passage of air through a wall.	
Bat	It is a portion of a brick cut across the width. (a cut brick)	
Beveled closer		It is the portion of a brick / stone in which the whole length is made for maintaining half width at one end and full width at the other.
Bond	The method of arranging bricks so that the individual units are tied together	
Bullnose	Bricks are of rounded edges, useful for window sills	
Cant brick		a header that is angled at less than 90 degrees
Brick	Various cut bricks usually at the ends of walls or reveals used to	

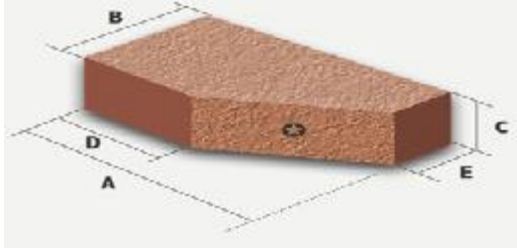
Closures	finish off the wall. Also called Closers	
Coping		It is the course placed upon the exposed top of an external wall to prevent the seepage of water.
Corbel		It is the extension of one or more course of stone or brick from the face of a wall to serve as a support for wall plates.
course	A course is a horizontal layer of bricks or stones.	
Cramp		a tie used to secure a window or door frame
Creasing	a flat clay tile laid as a brick to form decorative features or waterproofing to the top of a garden wall	
Dog leg		a brick that is specially made to bond around internal acute angles. Typically 60 or 45 degrees
Dog tooth		a course of headers where alternate bricks project from the face.

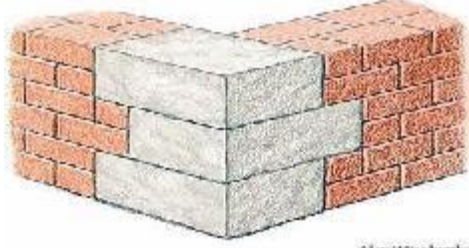
Fire wall		<p>a wall specifically constructed to compartmentalize a building in order to prevent fire spread.</p>
Honey comb wall		<p>a wall, usually stretcher bond, in which the vertical joints are opened up to allow air to circulate.</p>
Header		<p>Brick in widthwise</p>
King closer		<p>a brick that has been cut diagonally over its length to show a half-bat at one end and nothing at the other</p>
Queen closer		<p>it is the portion of a brick obtained by cutting a brick length-wise into two portions.</p>
Quoin		<p>The stones used for the corners of walls of structure.</p>
Racking back	<p>. stepping back the bond as the wall increases in height in order to allow the work to proceed at a future date</p>	
Squint	<p>a brick that is specially made to bond around external quoins of</p>	

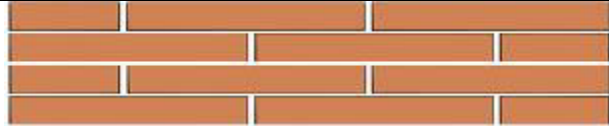
	obtuse angles. Typically 60 or 45 degrees	
Stretcher		
Vousoir	a masonry brick piece used in an arch, to ensure that the joints appear even.	

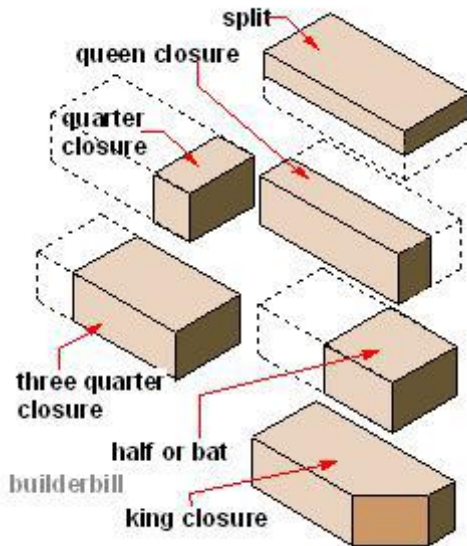

BRICK MASONRY:

Bricks are manufactured by moulding clay in regular blocks of predetermined size, drying and then burning in a kiln. Good bricks should be thoroughly burnt so that they become hard and durable.

Brick masonry is made of brick units bounded together with mortar. Brick masonry consists of two essential components such as bricks and mortar. Mortar acts as a cementing material and makes the individual brick units together to act as a homogeneous mass. Following types of mortar may be used in brick masonry:

Cement mortar
Lime mortar / Cement – Lime mortar
Mud mortar.

Cement mortars are used for high rise buildings whereas lime mortar / cement-lime mortar are used for all types of construction. Mud mortar is used only for low-rise buildings which carry light loads.

The strength of brick masonry chiefly depends upon:

Quality of bricks
Quality of mortar
Method of bonding

- Brick masonry is preferred due to the following reasons:

- All the bricks are of uniform size and shape and hence they can be laid in any definite pattern.
- Bricks are light in weight and small in size and can be handled easily by hand.
- Bricks do not need any dressing .
- Art of brick laying can be understood easily and even unskilled masons can do the brick masonry work.
- Bricks are easily available at all places and do not require transportation
- Light partition walls can be easily constructed .

TYPES OF BRICKS: Bricks used in masonry can be of two types: Traditional bricks are those which have not been standardized in size. The dimensions of traditional bricks vary from place to place. Their length, width and thickness vary from 20 – 25 cm; 10 – 13 cm and 5 – 7.5 cm respectively. The common size of traditional brick is 23 x 11.4 x 7.6 cm (9" x 4 ½" x 3").

Modular bricks confirm to the size as laid down by Bureau of Indian Standard (BIS). The nominal size of the modular brick is 20 x 10 x 10 cm while the actual size of the brick is 19 x 9 x 9 cm.

CLASSES OF BRICKS: Quality wise, masonry bricks are classified into three classes:

First class bricks: These confirm standard size, color and shape (19 x 9 x 9 cm size).

Second class bricks: These also confirm to the standard size but slightly irregular in shape and color.

Third class bricks are quite irregular in their size and shape and finish. These are not used for quality brick-masonry.

Moulded bricks are those which are manufactured in special shapes and sizes to be used for giving architectural shapes.

BONDS IN BRICK WORK / BRICK BONDING: The look of brickwork is greatly affected by the pattern the bricks are laid in, known as 'bonding'. The long face of the brick is called the 'stretcher' and the short face the 'header'; the arrangement of headers and stretchers normally follows a prescribed pattern. Bricks used in masonry are all of uniform size. If they are not arranged or bonded properly vertical joints result which cause for little strength and stability.

There are five commonly used bond patterns; Running Bond, Common Bond, English Bond, Flemish Bond, and Stack Bond. It is important that the corners be

started correctly when laying out any bond pattern.

Running Bond / Stretcher Bond:

The most common and simplest of pattern is the Running Bond. The length of the bricks are thus along the direction of the wall. This pattern is used as partition walls. The vertical mortar joints between stretchers line up vertically

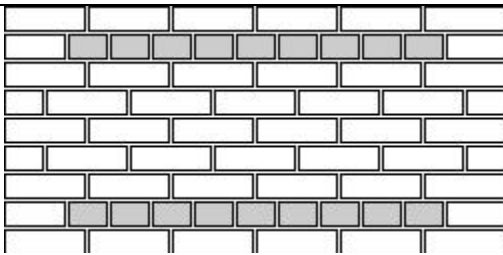
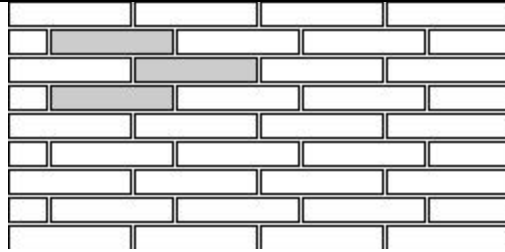

Common Bond / American Bond

This Pattern is with a course of full headers at regular intervals. These intervals may be every fourth, fifth, or sixth course. Three-quarters of a brick must be used at the corner of each header course.

English Bond

The English Bond pattern consists of alternate courses of headers and stretchers with the headers centered on the stretchers. Corners require a quarter brick closure.

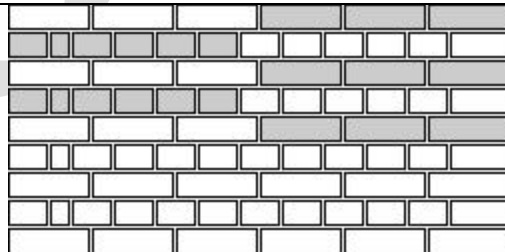

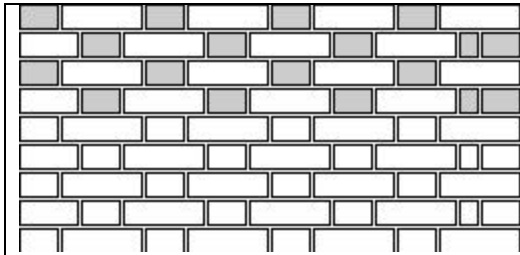

Flemish Bond / Dutch Bond

The Flemish Bond consists of alternate headers

and stretchers with the headers centered over

the stretchers in the intervening courses. The

corner requires a three-

Stack Bond

Also referred to as the Block Bond. All vertical mortar joints are aligned with no overlapping of units.

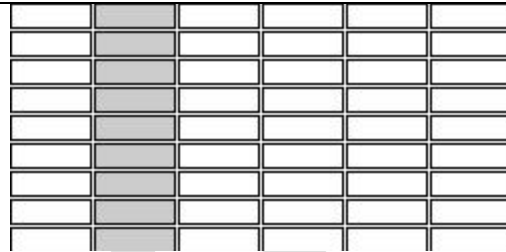

HEADER BOND is the one in which the width of the bricks are thus along the direction of the wall. This bond does not have strength to transmit pressure in the direction of the wall and this type of bond is unsuitable for load bearing walls.

FACING BOND is used where bricks of different thickness are to be used in the facing and backing of the wall. This type of bond is not structurally good and load distribution is not uniform.

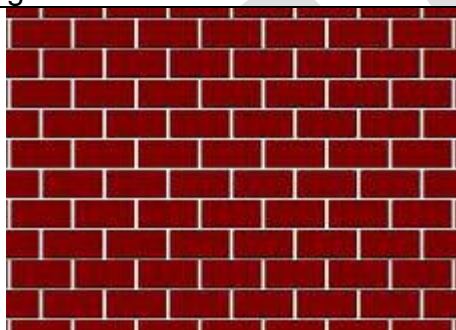

HEADER BOND



Facing bond

BRICK ON EDGE BOND (SILVERLOCK'S BOND / SOLDIER'S CASE) : This bond is weak in strength, but is economical. Hence, it is used for garden walls, compound walls etc.. The bricks are arranged as headers and stretchers in such a manner that headers are placed on bed and stretchers are placed on edge thus forming a continuous cavity. Due to this, the bond consume less number of bricks.

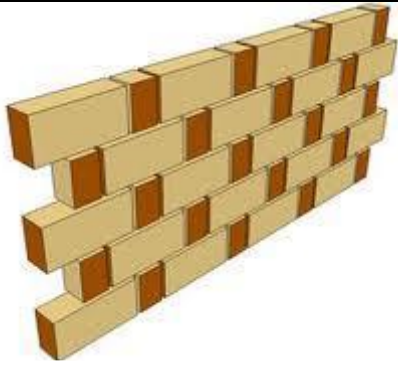

BRICK ON EDGE BOND

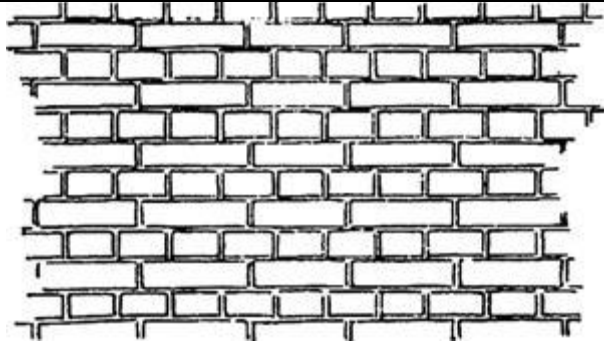

Silverlock's bond

RAKING BOND: This bond is used in thick walls. In this type of bond, the bricks are kept at an inclination to the direction of the wall. This bond is introduced at certain intervals along with height of the wall. Raking bonds are of two types:

Diagonal bond: In this type of bond, bricks are arranged at 45° in such a way that extreme corners of the series remain in contact with the external line of stretchers. Triangular and suitable sizes of bricks are packed at the ends. This bond is best suited for walls which are 2 – 4 bricks thick.

Herring – bone bond: This bond is more suitable for walls which are thicker than 4 bricks. Bricks are arranged at 45° in two opposite directions from the centre of the wall thickness. The bond is also used for face work and also for brick flooring.

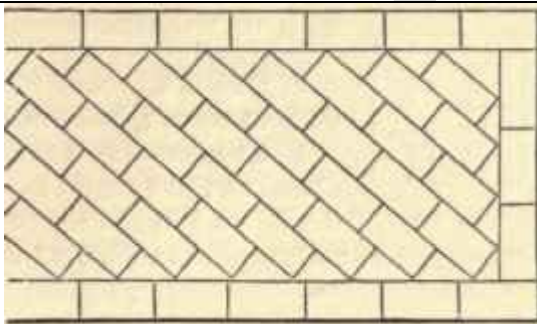

Diagonal bond



Herringbone bond

Zig-zag bond: This bond is similar to herringbone bond except that the bricks are laid in zigzag fashion and used in case of flooring.

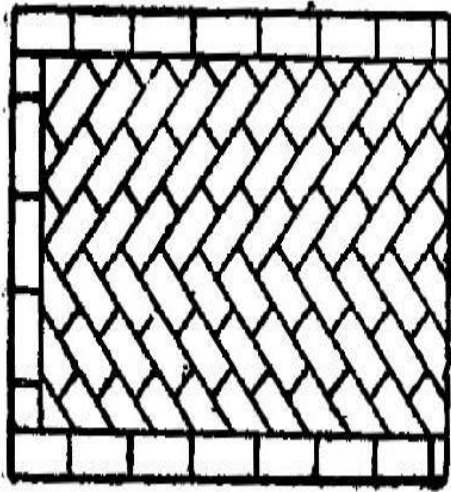

Zigzag bond

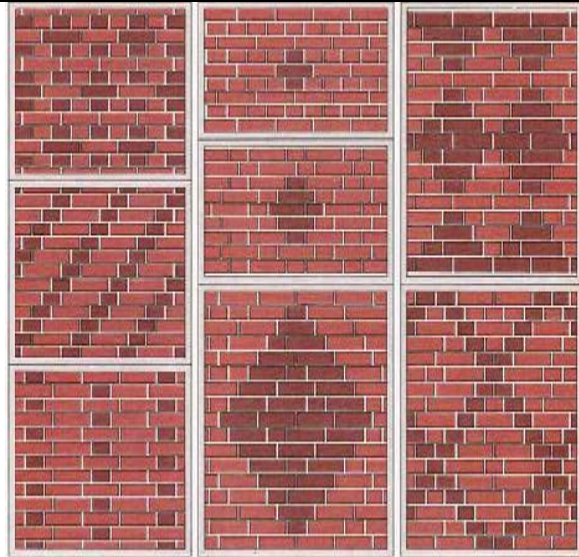

Fancy tricks with colored bricks

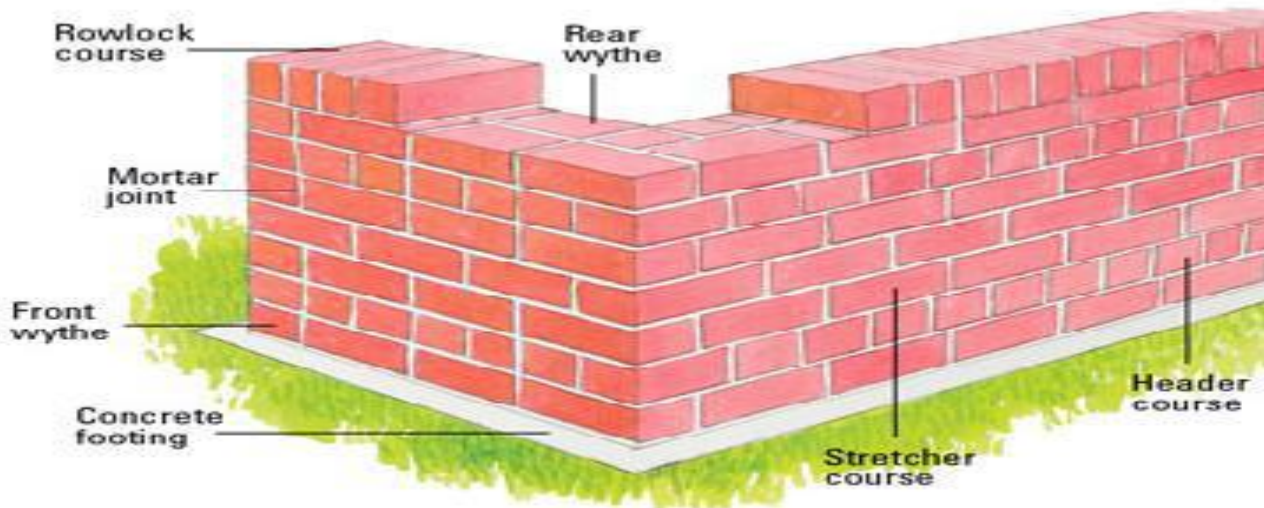

PLASTERING



Plastering is the process of covering rough surfaces of walls, columns, ceilings with a thin coat of plastic mortar to form a smooth surface. Plastering on external exposed surfaces is known as *Rendering*. Plastering is done to achieve the following objects:

- To protect the external surfaces against rain water and other atmospheric agencies.
- To give smooth surface in which dust and dirt cannot lodge.
- To give decorative effect.
- To protect surfaces against *Vermin*. (To protect the external surfaces against penetration of rain water)

- To conceal the defective workmanship.



TOOLS FOR PLASTERING:

Gauging trowel: It is used for gauging small quantities of materials and for applying mortar to corners. The end of the trowel blade may be either pointed or bull-nosed.

	
Pointed gauging trowel	Bull-nosed gauging trowel

Float: A float is used for applying and spreading mortar on the surface. It is made of either metal or wood. Metal float, made of thin tempered steel, is known as Laying trowel. The wooden float, commonly known as skimming float is used for the finishing coat of plaster.

The size of float varies from 10 x 30 cm to 11 x 33 cm with a thickness of 10 to 12 mm.

	
Float (metal)	Float (wooden)

FLOATING RULE: It is used for checking the level of the plastered surface between successive screeds.

MISCELLANEOUS TOOLS: These include plumb bob; spirit level, set square, straight edges brushes, scratchers etc...

METHODS OF PLASTERING: For plastering new surfaces, joints should be raked to a depth of 10 mm in brick masonry and 15 mm in stone masonry. All mortar droppings, dust, laitance (an accumulation of fine particles on the surface of fresh concrete) should be removed with the help of stiff wire brush.

Any unevenness is leveled before plastering. For finishes applied in three coats, local projections should not be more than 10 mm and local depressions should not exceed 20 mm. For two coat plaster, these limitations are 5 mm and 10 mm respectively.

The surface should be washed with clean water. If plaster is to be applied on old surfaces, all dirt, soil, oil, paint etc.. should be cleaned off.

TYPES OF MORTARS FOR PLASTERING: Following types of mortars are commonly used for plastering.

LIME MORTAR: Lime used for plastering may be either Fat lime or Hydraulic lime. However, fat lime is preferred since it yields good putty after slaking. If hydraulic lime is used for plastering, it should be ground dry with sand. It is then left for 2 to 3 weeks and then reground before use. The mix proportion of lime and sand varies from 1: 3 to 1: 4 for Fat lime and 1 : 2 for hydraulic lime.

The adhesive and tensile properties of lime mortar can further be improved by mixing chopped hemp (The tough, coarse fiber of the cannabis plant) at the rate of 1 kg per cubic metre of mortar. Such a treatment prevents the formation of Tensile Cracks on the plastered surface.

CEMENT MORTAR: Cement mortar is the best mortar for external plastering work. It is preferred even in damp climates. Cement mortar is much stronger than lime mortar. The mix proportion of cement and sand may vary from 1:4 to 1:6. Sand used for plastering should be clean, coarse and angular. Before mixing water, dry mixing is thoroughly done.

LIME CEMENT MORTAR: Lime - cement mortar contains properties of both the lime mortar as well as cement mortar. Cement mortar alone itself doesn't possess sufficient plasticity, addition of lime to it impart plasticity, resulting in smooth plastering surface. Mix proportion used as 1:1:6 (Cement : Lime : Sand) . Generally fat lime is used.

NUMBER OF COATS OF PLASTER:

The background over which plastering is to be done depend upon the type of wall construction such as rubble masonry, cement masonry, brick masonry et. Different thickness of plaster is required for different types of backgrounds. Plastering is therefore, applied in one, two or three coats.

Plaster in one coat is applied only for inferior work (poor quality). Generally, lime plaster is applied in three coats while cement plaster is applied in two coats.

The first coat (rendering coat) makes leveling an uneven surface. It seals the surface of wall and to some extent prevent rain water penetration.

The second coat is known as Floating coat and the third or final coat is known as setting coat or finishing coat which provide smooth surface. The average thickness of rendering coat and floating coats may be 10 -15 mm and 6 – 9 mm respectively. The finishing coat may be 2 – 3 mm thickness.

MATERIALS USED IN PLASTERING:

A few special materials are used in plastering to meet some specific requirements such as increased durability, attractive appearance, fire proofing, sound insulation / heat insulation etc.... Following are the usual special materials used for plastering the surfaces.

- 1. Accoustic Plaster:** This type of plaster contains gypsum mixtures applied as final coat, Such a coat undergoes chemical reaction resulting in production of gas bubbles and consequent formation of tiny openings in the coat. These minute openings absorb sound. Such plaster is useful in the interior walls of halls, auditoriums etc.. The plaster is applied in two coats each of 6 mm thick.

- 2. Asbestos marble plaster:** This plaster is made of cement, asbestos and finely crushed marble powder, to get marble like finish.

- 3. Barium plaster:** It is made from cement, sand and $BaSO_4$ and is coated in Xray rooms to protect from harmful rays to the persons working in it.

- 4. Granite Silicon plaster:** This plaster is used for superior type of construction since it makes the setting time quickly and possess highly elastic properties which eliminate cracks.

- 5. Plaster of Paris: (Gypsum plaster) :** Plaster of Paris is obtained from heating finely ground gypsum which is heated at $160^{\circ}C - 170^{\circ}C$. It hardens within 3 - 4 minutes of adding water. To extend the softening time, suitable retarders are used. Plaster of Paris is generally used in construction with lime for repairing cracks, filling of holes etc... due to the following properties.
 - It is fire resisting and can be effectively used on timber components of a building.
 - It is light weight.
 - It has sound insulating property.
 - It sets quickly with little change in volume.

However, gypsum plaster (POP) is soluble in water, hence it can be used only for interior works.

- 6. Kennee's cement plaster:** It is obtained by the calcinating POP with alum. This is very hard and sets in few days, taking white, glass like polish. Because of its polishing characteristics, it is useful for decorative works.

- 7. Parian cement plaster:** This plaster is obtained when borax is calcined with pop. Like kennee's cement, it is also used for interior works. However, it is cheaper than kennee's plaster.

- 8. Sirapite plaster:** It is obtained when Plaster of Paris is slaked in petroleum. It is quick setting and fire resisting.

Pointing

The term pointing is applied to the finishing of joints in masonry works. Joints are considered to be the weakest and most vulnerable spots from which rain water can enter.

The type of joint between bricks affects not only a wall's appearance, but also the mortar's resistance to weather and, in turn, the longevity of the entire wall.

Pointing is a process of raking the joints to a depth of 10 – 20 mm and filling it with better quality mortar in desired shape. Pointing is done with the following mortar mixes:

1. Lime mortar – 1:2 mix (1lime : 2 Sand)
2. Cement mortar – 1: 3 mix (1 cement : 3 Sand)

Before pointing, the old or new surfaces are raked down to a depth of 20 mm wherever the joints are exposed. The joints and surface are cleaned and then thoroughly wetted.

After preparing the surface as desired, the mortar of any kind is carefully placed in the joints. A small trowel is used for placing the mortar in the joints by applying pressure. The pointed surface is kept for atleast a week or till it sets after application.

Types of Pointing: Pointing is carried out in the following common shapes:

1. Flush Pointing: This type of pointing is formed by pressing mortar in the raked joints and by finishing the edges or neatly trimmed with trowel. This type of pointing is more durable since it doesn't provide any space for the accumulation of dust, water etc

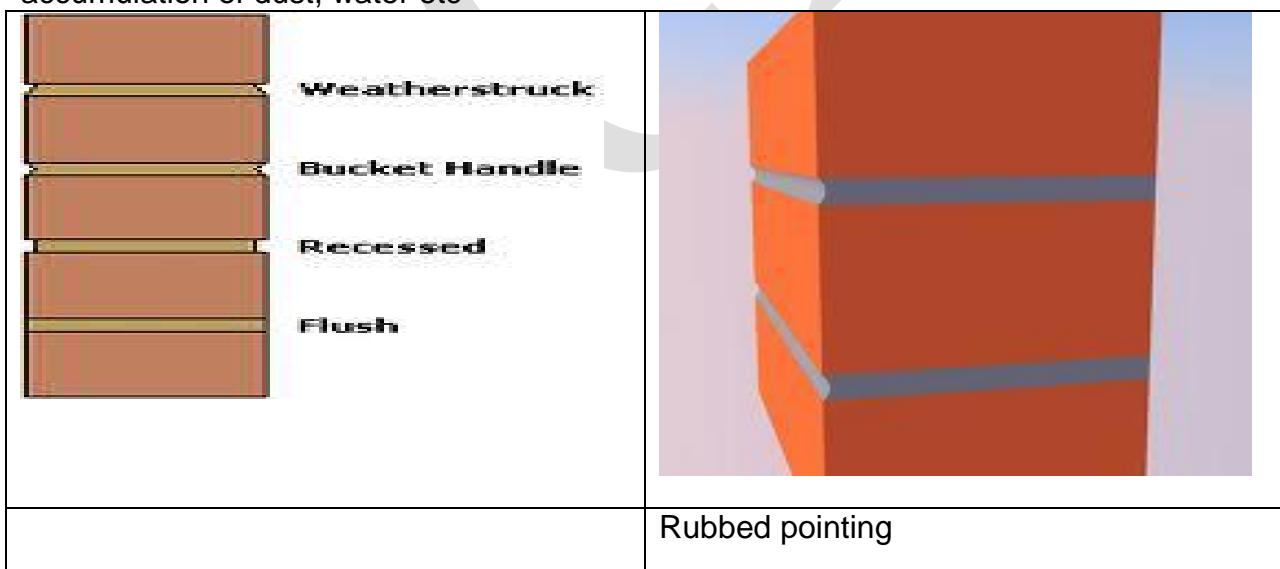

2. Recessed pointing: The pointing is done by pressing the mortar back from the edges by 5 mm or more. The pointing gives very good appearance.

3. Rubbed / Grooved pointing: This pointing is obtained by forming a groove

at its mid height by a painting tool.

4. Beaded pointing: This is the special type of pointing formed by a steel or ironed with a concave edge. It gives good appearance but is liable to damage easily.

5. Struck pointing: This is a modification of flush pointing in which the face of the pointing is kept inclined by pressing the upper edge inside. This pointing drains water easily.

6. V- Pointing: This pointing is formed by forming V- groove in the finishing face.

7. Weathered pointing : This pointing is made by making a projection in the form of V- shape.

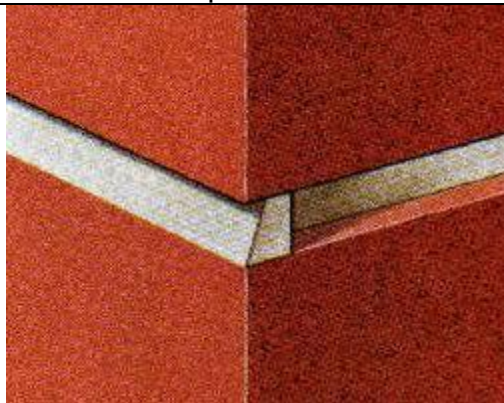

Weathered pointing

PAINTING

An ideal paint should have uniform spread as a thin film, high coverage, good workability and durability. The paints should also be cheap and economical

Paints are classified as oil paints, water paints, cement paints, bituminous paints, fire proof paints, luminous paints, chlorinated rubber paints (for protecting objects against acid fumes.

Paints are liquid compositions of pigments (a substance that gives something colour) which when applied to the surface in thin coats, forms a solid film to impart the surface a decorative finish. Painting gives the protection to the materials such as concrete, plaster surfaces, wood and metal surfaces etc from weathering, corrosion and other chemical and biological attacks. Paints preserve timber against decay. Most of the metals corrode if not painted at certain intervals.

Characteristics of an ideal paint: An ideal paint should possess the following characteristics:

- Painting over surfaces give the durability of a material.
- It gives attractive appearance.

- It should be cheap and readily available.
- It should be applied to the surfaces in an easy way.
- It should have good spreading quality, so as to cover maximum area in minimum quantity of paint.
- It should dry in reasonable time without any hair cracks after drying.
- It should form film of uniform color on drying.
- It should be stable for a longer period.
- It should not be affected by atmospheric agencies such as temperature, rain etc..

TILES

Tiles are thin slabs of low melting clays used for various purposes in engineering constructions. Flooring tiles, Roofing tiles, wall tiles and partition tiles are some of the examples and they give a very pleasing appearance.

Clays and shales are used in making tiles for floor surfaces. Wall tiles differ from floor tiles principally in degree of burning. Wall tiles are burned at a comparatively low temperature and fired again in muffle kiln at a still lower temperature.

Tiles are made of clay (pottery) or terrazzo. These are available in different sizes and thickness. These are commonly used in residential houses, offices, schools, hospitals , etc.....

Tiles are made in the same manner as bricks, but are thinner and lighter, so require greater care. These are manufactured from a clay mass with or without colouring agents by moulding in machines and subsequent burning upto 1300°C, in continuous kilns.

The following tiles are of three classes -- class 1, 2 and 3 and these are available in the following sizes:

150 x 150 x 15 mm	200 x 200 x 20 mm	250 x 250 x 30 mm
150 x 150 x 20 mm	200 x 200 x 25 mm	

Characteristics: A good tile should have the following properties:

- Uniform texture
- Accurate size & shape
- Free from cracks
- Water absorption of < 15%
- Resistant to atmospheric conditions
- Long durability

- Greater care is required for laying of tiles. Over the concrete base, a 25 – 30 mm thick layer of lime mortar 1 : 3 (1 lime : 3 sand) is spread to serve as building / bedding. This bedding mortar is allowed to harden for 12 – 24 hours. Before laying the tiles, cement slurry is spread over the mortar and the tiles are laid over it by gently pressing.

- A thin paste of cement is applied on the sides of tiles, so that the tiles have a thin coat of cement, mortar over the entire perimeter surface. The tiled flooring is then cured for 7 days.

TESTING OF TILES: Various types of tiles must comply the following tests:

- The roofing tiles must comply with two tests....viz the transverse strength test and the water absorption test.
- Ridge tiles are tested for Water Absorption test and Breaking strength test.
- Flooring tiles needs Impact test, Transverse test and Water Absorption Test.

The Transverse Strength Test (IS 2690): It consists of applying the load along the centre line at right angles of the tile (which has been immersed in water for twenty four hours). Six tiles are tested and the average breaking should not be less than as specified in the code.

The rate of loading is kept uniform and may vary in the range of 450 – 550 N/minute.

Strength (N / mm²) = $15 W S / bt^2$ where W = breaking load
S = span in mm ($\frac{3}{4}$ of tile)
b = width
t = thickness

Water Absorption Test (IS 2690): Six tiles are dried in oven at 105°C and cooled at the room temperature. They are then immersed in water for 24 hours. Thereafter, wiped dry and weighed.

Absorption in % = $(W2 - W1 / W1) * 100$ where W1 and W2 are the respective weights of dry and the immersed specimens.

Impact Test (IS 1478):
Breaking test (IS 1464):

 			
Transverse test machine	Water absorption test machine	Impact test machine	Breaking /abrasion test machine

FORM WORK

Introduction: The form work or shuttering is a temporary construction used as a mould for a civil structure, in which concrete is placed. The construction of form work involves considerable expenditure of time and material. The cost of form work may be upto 20 – 25 % of the cost of the structure in building works and even higher in bridges. In order to reduce this expenditure, it is necessary to design economical types of form work and to mechanize its construction.

When the concrete has reached a certain required strength, the form work is no longer needed and is removed. The operation of removing the form work is commonly known as Stripping. Similarly, when the components of form work are removed and then reused for another parts of the civil structure and reused the components for several times are known as Panel forms.

Forms are classified as wooden, plywood, steel, combined wood – steel etc.. Timber is the most common material used for form work. The disadvantage of wooden form work is the possibility of warping, swelling and shrinkage of the timber. However, those effects can be overcome by applying shuttering oil as coating. This coating also prevents the material from adhering to concrete and hence the stripping (removing of formwork material) makes easier.

Steel shuttering is used for major work where everything is mechanized. However steel form work is comparatively more costly. Form work has many advantages such as

- Can be used a number of times
- It provides ease stripping
- It ensures an even and smooth concrete surface.
- It is not liable to shrinkage.

Requirements:

A good form work should satisfy the following requirements:

- The material of the formwork should be cheap and it should be suitable for re-use several times.
- It should be water proof so that it doesn't absorb water from concrete.
- Shrinkage and swelling of material should be minimum.
- It should be strong enough to withstand all loads coming on it such as dead load of concrete, live load of concrete during its pouring, compaction and curing.
- The surface of the form work material should be smooth and should afford easy stripping.
- All joints of the form work should be stiff so that lateral deformation under loads is minimized.

Indian Standards on form work (IS 456 – 2000)

General: The formwork shall conform to the shape, dimensions etc as shown on the plans and so constructed as to remain the rigidity during the placing of the concrete and the form work shall be sufficiently tight to prevent loss of liquid from the concrete.

Cleaning and treatment of forms: All rubbish particularly chippings, saw dust shall be removed from the interior of the form work material before the concrete is placed.

Stripping time: When possible, the form work material should be left longer as it would assist the curing. In normal circumstances (generally where temperatures are above 20°C) and where ordinary cement is used, form materials may be struck after the following periods:

Walls, columns etc... 24 to 48 hours

Slab soffits (props left under) 3 days

Beam soffits (props left under) 7 days

Removal of props to slabs

- (a) Spanning upto 4.5 m ----- 7 days
- (b) Spanning over 4.5 m ----- 14 days



Removal of props to beams and arches

- (a) Spanning upto 6 mts ----- 14 days
- (b) Spanning upto 6 mts ----- 21 days

Procedure to be adopted for removing the form work

All form work materials are to be removed without creating vibrations as would damage the reinforced concrete. Before the soffits and struts are removed, the concrete surface should be checked thoroughly.

Tolerances: Form work shall be so constructed that the internal dimensions are within the permissible tolerance specified by the designer.

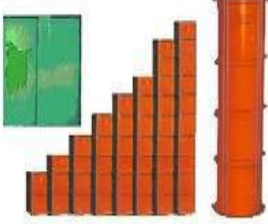
		
<p>Formwork material (PLYWOOD)</p>	<p>modular steel frame work</p>	<p>Plywood Column Boxes</p>
		
<p>reusable plastic form work</p>	<p>steel and plywood formwork</p>	<p>Column boxes</p>

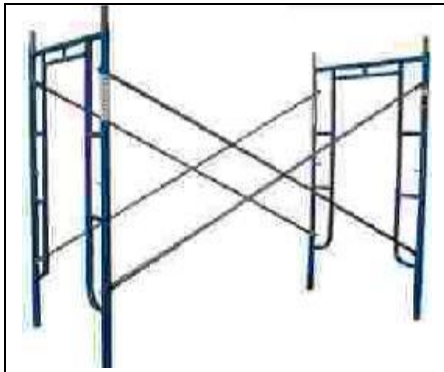

Shoring frame



H – frame



Adj stirrups



Adj base plates



Props



Cup lock system

Scaffolding

When the height of wall or column or other structure of a building exceeds about 1.5 mts, temporary structures are used to support the platform over which the work men can sit and carry the activities. These temporary structures constructed are very close to the wall, is in the form of timber or steel frame work, commonly called scaffolding.

Scaffolding materials is also needed for the repairs or even demolition of a building. The scaffolding should be stable and be strong enough to support work men and other construction material placed on the platform supported by the scaffolding. The height of the scaffolding goes on increasing as the height of construction increases.

Components of Scaffolding:

Standards : These are the vertical members of the frame work supported on the ground or embedded into the ground.

Ledgers: These are horizontal members, running parallel to the wall,

Braces: These are diagonal members fixed on standards.

Putlogs: These are transverse members, placed at right angles to the wall with one end supported on ledgers and other end on the wall.

Transoms: These are those putlogs whose both ends are supported on ledgers.

Boarding: These are horizontal platform to support workmen and material and are supported on the putlogs.

Various components or members of the scaffolding are secured by means of rope lashings, nails bolts etc.....

		
<p>Standards / verticals</p>	<p>Ledgers</p>	<p>Braces to standards</p>
		
<p>Putlogs (p = putlog hole)</p>	<p>Transoms</p>	<p>Boarding</p>

 <p>shuangfeifastener@163.com</p> <p>Powered by 100% Load.com</p>	 <p>shuangfeifastener@163.com</p>	
<p>Cuplock material for shuttering</p>	<p>Flathead pin</p>	<p>braces</p>

Types of Scaffolding:

1. Single / putlog scaffolding: In case of brick masonry all the standards, ledgers, putlogs are arranged parallel to the wall at distance of 1.20 mts.
2. Double scaffolding: In case of stone masonry works, it is difficult to provide holes in the walls to support putlogs.
3. Cantilever/needle Scaffolding: where ground is weak to support the standards.
4. Suspended scaffolding: light weight scaffolding material used for repair works such as pointing, painting etc..
5. Trestle scaffolding: the working platform is suspended from roofs by means of wire ropes or chains. Such type of scaffolding is used for painting and repairing works inside the room upto a height of 5 mts. Tripods, ladders etc mounted on wheels.
6. Steel scaffolding: It is practically similar to timber scaffolding except that wooden members are replaced by steel tubes. Such a scaffolding can be erected and dismantled rapidly. Though its initial cost is more but its salvage (The property so saved) value is higher.
7. Patented scaffolding: These scaffoldings are equipped with special couplings, frames etc.. the working platform is supported on brackets which can be adjusted at any suitable height.

SHORING

Shoring is a temporary structure to support an unsafe structure . Shoring can be used in case of

- (a) A wall cracks due to unequal settlement and need repairs.
- (b) When an adjacent structure is to be dismantled.
- (c) When openings are to be made or enlarged in the wall.
- (d) When a wall shows signs of bulging due to improper workmanship which needs rectification.

Types of shores:

Raking Shores: Rakers of inclined members are used to give lateral support to the wall. Usually a raking shore consists of the following components:

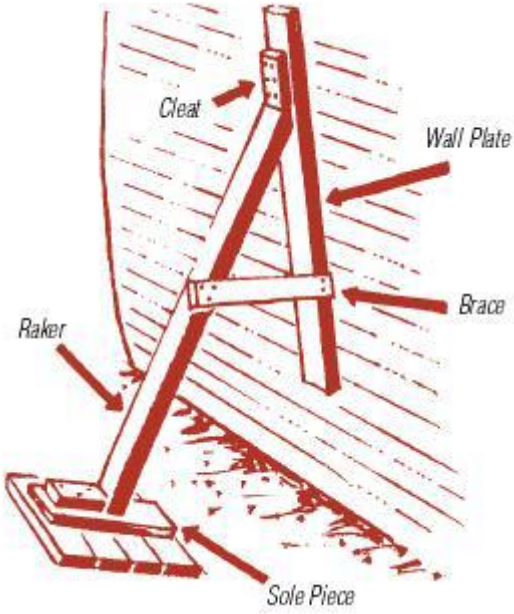
	<ul style="list-style-type: none">• Rakers / inclined members• Wall plates• Needles• Cleats• Bracings• Sole plates• Folding wedges
Raking shore	

The sole plate should be properly embedded into the ground at an inclination and the sole plate should be accommodate all the rakers and a cleat provided along the outer edge. For tall buildings the length of rakers can be reduced by introducing Rider Raker. However the rakers should be inclined to the ground by 45° to make them move effective.

Flying or Horizontal Shores: Such shores are used to give horizontal support to two adjacent walls in which the shores do not reach the ground. If the walls are quite near to each other (distance upto 9 mts), single flying shore can be constructed. It consists of wall plates, needles, cleats, struts, horizontal / flying shore, folding wedges etc.... When the distance between the walls is more, a composed or double flying shore may be provided.

Flying shores have the advantage that building operations of the ground are not obstructed. Flying shores are inserted when the old building is being removed, and should be kept in position till the new unit constructed.

Dead or Vertical Shores: These consists of vertical members which support the horizontal members (needles). The horizontal members transfer the load of the wall to the vertical shores (vertical members). Such vertical shoring is provided to serve the following purposes.

- To rebuild the defective part of the lower portion of the wall;

- To deepen the existing foundations.
- To make large openings at lower levels.

Holes are made in the wall at suitable heights and the horizontal members, which are made of thick wooded sections or of steel are inserted in the steel. Each horizontal is supported at its two ends by vertical posts / dead shores.

The horizontal members are spaced at 1 to 2 mts. A minimum of 3 horizontal shores should be used for an opening. If the external wall is weak, raking shores may be provided in addition to vertical shores.

Shores should be removed only when the new work has gained sufficient strength, but in no case earlier than 7 days of the completion of new work. An interval of two days should be allowed between each one of these removal operations.

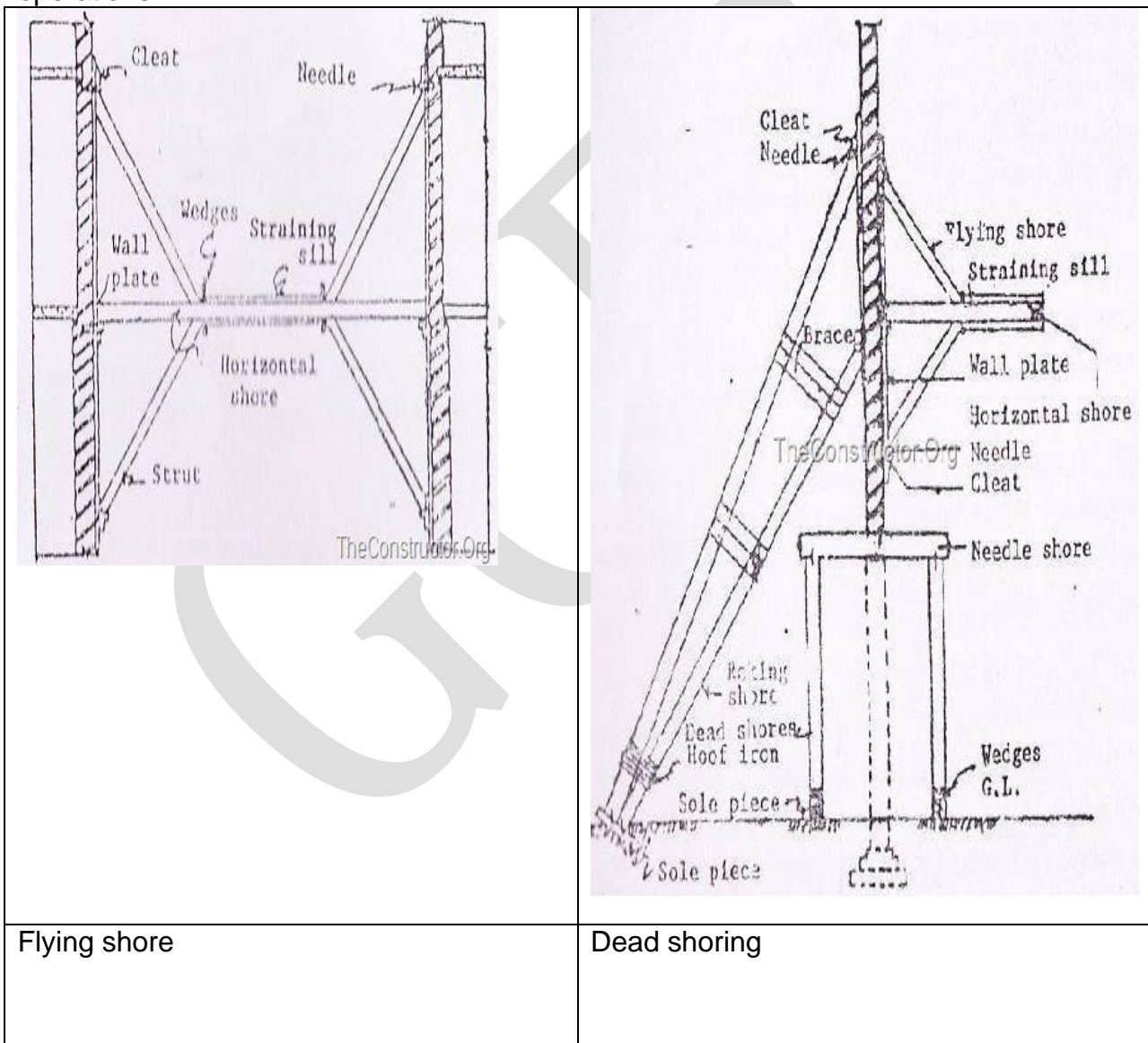

UNDER PINNING

The process of placing a new foundation under an existing one or strengthening an existing foundation is called underpinning of foundations. Under pinning may be required to serve the following purposes

- 1 To strengthen existing foundation which has settled and caused cracks in the wall.
- 2 To deepen the existing foundation to bear higher bearing capacity.
- 3 To construct a basement in the existing building.

Underpinning can be carried out by the following methods

- 1 Pit method
- 2 Pile Method

UNIT V: BUILDING PLANNING

A building consists of a number of rooms including toilets / bath rooms, kitchen, Hall, bed rooms etc interconnected through corridors, passages and each room may contain a number of doors, windows, almirahs, cup boards whereas building drawing reveals the details of all building elements such as foundations, doors, windows, lintels, arches, roofs, floors, sanitary and electrical fittings. Usually these fittings represent symbolically. The graphical symbols are the shortest forms of the objects and components. Hence, drawing is the language of Engineers and Architects.

BUILDING PLANS: A plan is the graphical representation to some scale on the surface of the earth as projected and represented on the paper on which the plan is drawn. In order to represent these elements on a plan, the plan is conventionally prepared at the window sill level (The horizontal member at the base of a window opening) rather than at the plinth level (Within the context of construction, it is the top of the foundation walls).

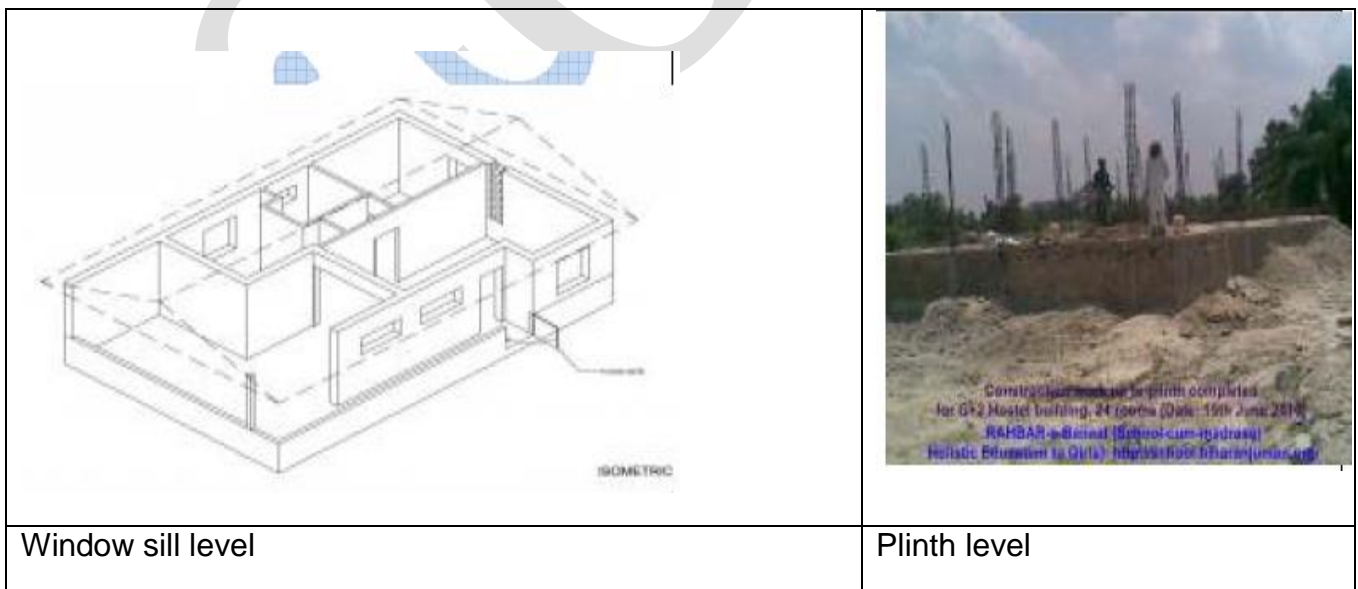

The art of arranging various units of a building on all floors and at ground level giving due consideration to planning, drawing; architectural, engineering, finance and management aspects is known as building planning. Hence, the building planning include drawing and is the

foundation subject for civil engineering students.

A building may be completely represented by the following types of plans:

Plan of a typical floor: The plan of a typical floor (ground floor plan at ground floor level , first floor plan at first floor level) is represented by a plan cut at the window sill level so that all the windows, cup boards, almirahs etc are also represented on the plan.

Foundation plan: Foundation is immediate beneath the lowest part of the structure, near to the ground level is known as shallow foundations. Such foundations are mostly placed on the hard strata available below the ground level.

Shallow foundations are further classified into the following types:

1. Open trench foundations
2. Grillage foundations
3. Raft foundations
4. Stepped foundations
5. Inverted arch foundations

Structural plan of a typical floor: A structural plan of a typical floor contains location, nomenclature and details of various structural elements at that floor level.

Terrace plan. The terrace plan is the plan at the roof level showing the stair cabin, lift cabin, overhead water tanks alongwith roof drainage pattern, parapet walls etc.

Classification of buildings: According to National Building code of India 1970, ***different classification of buildings*** on the basis of occupancy are:

Group A – Residential Buildings: All those buildings in which sleeping accommodation is provided for residing permanently or temporarily with or without cooking or dining or both facilities are termed as residential buildings, for example Apartments, Flats, Bungalows, Dormitories, Private Houses, Hotels, Hostels, Cottages, Holiday Campus, Clubs, outhouses, Inns, etc., These buildings are further sub-divided in to 5 groups, namely; A- 1 Lodging Houses; A- 2 Family Private Dwellings; A- 3 Dormitories; A- 4 Flats; and A- 5 Hotels.

Group B – Educational Buildings: All those buildings which are meant for education from a nursery to the university, are included in this group, for example, schools, colleges, Universities, Training Institutes, etc. These buildings provide facilities like class – rooms, staff cabins, drawing rooms, laboratories, admin blocks, seminar halls; recreation halls, library, playfields, gymnasium etc.

Group C – Institutional Buildings: This group includes any building which is used for the purposes such as medical, health, physical or mental disease, care of infants or aged persons, etc. These buildings normally meant for healthcare for the occupants.

These buildings are further sub – divided into three groups viz., C – 1 Hospitals ; C - 2 Custodian Institutions (a financial institution that has the legal responsibility for a customer's securities) and C - 3 panel Institutions (a group of persons selected for some services).

Group D – Assembly Buildings: This group includes any building where groups of people assemble or gather for amusement / entertainment. For eg: theatres, cinema halls, assembly halls, auditoriums, exhibition halls, museums, restaurants, places of worship (temple, mosque, church, etc.), club rooms, passenger stations, public transportation services; open air theatres, sports pavilions(i.e., stadium), swimming pools, etc.

Group E – Business Buildings : A **commercial building** is a building that is used for commercial use. Types can include office buildings, warehouses, shopping malls, etc

Group F – Mercantile Buildings: This group includes any building or part of a building which is used as shops, stores, market for sale and display of products or wares either wholesale or retail.

Group G – Industrial Buildings: This group includes any building in which products of different kinds and properties, are fabricated, assembled or processed. For example, laboratories, assembling plants, laundries, gas plants, power plants, refineries, dairiesA

Group H – Storage Buildings: This group includes to store materials such as cement, iron/steel; home appliances etc. eg: godowns

Group I – Hazardous Buildings: This group includes those building structures which are used for the storage, handling, manufacture/ processing of materials which are liable to burn and prove hazardous to building contents. Hazards may be due to fire, poisonous fumes or gases , explosions, ignition, etc., from materials subjected to various operations. Buildings used for storage of explosive materials, manufacture of synthetic leather, explosives, fire works, etc., .

BASIC PRINCIPLES OF BUILDING PLANNING: The basic principles of building planning in respect of residential buildings are:

(1) **FLOOR AREA RATIO (FAR)** is the ratio of the total covered area of all floors in a building on a certain plot and to the area of the plot.

The Floor Area Ratio, describes the relationship between the size of a plot and the amount of floor space it contains. For example, a 50' x 100' lot (5,000 sft) with a single-story 50' x 50' building (2,500 sft) has a floor area ration of 0.5. If a building with the same size footprint had 4 stories, the FAR would increase to 2. Higher FARs tend to indicate more urban (dense) construction and is used by local governments in zoning codes.

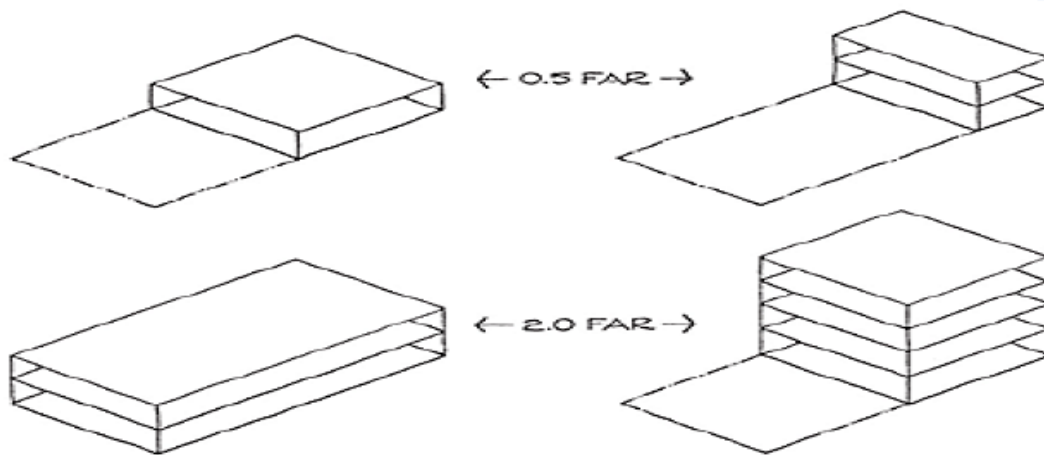

FLOOR AREA RATIO

(2) FLOOR SPACE INDEX (FSI): It is the ratio of built up area inclusive of walls of all the floors and to the area of the land on which the building stands.

$$\text{Floor Space Index} = \frac{\text{Total floor area including walls of all floors}}{\text{Plot Area / Building Unit}}$$

Thus, an FSI of 2.0 would indicate that the total floor area of a building is two times the gross area of the plot on which it is constructed, as would be found in a multiple-story building. **FSI for residential buildings in the city area is 4.** The value of FSI is fixed by local authority and it is different for different areas and for different buildings of the town.

Use	Area	FSI	Remarks
Residential	Scheme	1	Only Ground floor is allowed.
Residential	City area	4	Facing street of > 12 mts width
Residential	City are	3	Facing street of < 12 mts width

(3) ROAD SIDE MARGIN:

	Minimum Road Side Margin (mts.)	Remarks
Road up to 9mts . and less	. 3.00	(1)For the existing built up area the margins requirement may be relaxed on merits of individual case subject to other regulations.
More than 9 mts and upto 12 mts	. 4.50	
More than 12 mts and upto 18 mts	. 6.00	
More than 18 mts and upto 40 mts	. 7.50	
More than 40 mts	. 9.00	
		(2) Minimum side Margin shall be provided as per regulation no. 12.4.1(A)(ii).

(4) THE AREA OF ROOMS:

Bed rooms, living rooms, drawing room, dining room (min)	A.9.4 sq mts
Kitchen and store rooms (min)	5.45 sq mts
Bathrooms and dressing rooms	A 1.85 – 4.5 sq mts
Water Closet (WC); Urinal rooms . (min)	0.89 – 1.1 sq mts

(5) HEIGHT OF ROOF: Roof height on each floor is 2.7 mts (min) and for bath room and WC is 2.1 mts (min)

(6) AREA OF DOORS, WINDOWS & VENTILATORS: This shall be 1/6th to 1/10th of the floor area of the room. In addition, every room should have ventilator .

(7) STAIR CASE: The stair case shall have area not more than 12 sq mts. The pitch shall be in the range of 30° to 45° and flight shall have steps neither < 3 nor > 12. Minimum width of stair shall be 900 mm.

(8) LIFT: This shall be provided for buildings having more than 3 floors excluding the ground floor.

(9) SEPTIC TANK: shall be provided as per number of floors / rooms .

(10) HEIGHT OF COMPOUND WALL: The maximum height of compound wall on road side shall not be more than 1.5 mts and the gates shall open inwards. On other sides, the height of compound wall shall be 1.8 mts.

(11) OPEN SPACE: The open space width shall be 1.8 mts (min) and 3 mts (max) for front, rear and sides .

(12) **PARKING SPACE:** Parking spaces for cars required for cinemas, shopping areas and offices located in central areas are to be allocated as per National Building Code.

BUILDING BYE-LAWS: Every locality has its own peculiarities in respect of weather conditions, availability of material and labour and thus adopts its own method of construction. In addition, every locality has certain rules and regulations which help in controlling the development of locality. The rules and regulations covering the requirements and ensure the safety of the public, minimum use of rooms , area limitations are known as “Building bye-laws”.

Building bye-laws are necessary to achieve the following objects:

- Gives guidelines to the architects / engineer and thus help in preplanning the building activities.
- Allow to prevent haphazard development
- Afford safety against fire, noise pollution, structural failures etc..

While framing building bye-laws assistance of experts on various subjects such as town planning, law, health, civil engineering, traffic, general administrations etc should be sought due its weightage.

Indian Standard Institution, an organization of Govt of India has published IS 1256 “code of building laws” covering all the salient aspect of building activities.. National Building Code (NBC) was published by the Govt of India for smooth running of building activities by realizing the importance of building bye-laws.

EARTHQUAKE RESISTANT BUILDINGS: Earthquake causes ground motions in random fashion, both horizontally and vertically and also in all directions radiating from the epicenter. The intensity, duration of seismic vibrations depends upon magnitude of the earthquake , its depth of focus, distance from epicenter etcA characteristics It is therefore essential to ensure (i) stability, (ii) strength (iii) serviceability by means of design of the building.

Earthquake causes shaking of the ground so that a building resting on it will experience motion at its base and leads to collapse finally due to the resulting inertia forces.

From Newton’s first law of motion even though the base of the building moves with the ground, the roof has of tendency to stay in its original position. But since the walls and columns are connected to it, they drag the roof along with them. This gives rise to ***inertia forces*** on the roof

element

..
Structural elements such as floor slabs, walls, columns and foundations and the connections between them must be designed to safely transfer these inertia forces through them. Walls or columns are the critical elements in transferring the inertia forces. But , in traditional construction, slabs and beams receive more care and attention during design and construction than walls and columns. Failure of masonry walls have been observed because of their thin and materials used for it , in the past due to earthquake effect. Hence, importance also is to be given for walls and columns.

Twist in buildings due to earthquake induces more damage of window frames and walls. It is best to minimize this twist by ensuring that buildings have symmetry in plan. Indian Seismic Code (IS 1893: 2002) has provisions to come certain issues.

INDIAN SEISMIC CODES for earthquake resistant building: An earthquake resistant building has the following virtues:

(i) Good structural configuration: Its size, shape and structural system carrying loads are such that they ensure a direct and smooth flow of inertia forces to the ground.

(ii) Adequate stiffness: Load resistant system is to be followed so that the earthquake induced deformations in it do not damage under low to moderate shaking.

(iii) Lateral strength : The maximum lateral (horizontal) force can resist the damage induced by an earthquake.

(iv) Good ductility: Favourable design and detailing strategies resist the building from the earthquakes.

Considerable factors in case of earthquake zones:

Walls transfer loads to each other at their junctions and hence the masonry courses from the walls meeting at corners must have good interlocking.

Large openings weaken walls from carrying the inertia forces and it is best to keep all openings as small as possible and as far away from the corners as possible.

A variety of masonry units are used in the country eg clay bricks, concrete blocks, stone blocks. Since bricks are inherently porous and absorb water resulting in poor bond between brick and mortar. Hence, bricks with low porosity are to be used to minimize the amount of water drawn away from the mortar.

Various mortars are used eg mud, cement – sand, cement-sand-lime. Bricks must be stronger than mortar. Excessive thickness of mortar is not desirable. Indian Standards prescribe the preferred types and grades of bricks and mortars to be used in buildings in each seismic zone.

Wall thickness should not exceed 450 mm. Round stone boulders should not be used in the construction.

Since the earthquake force is a function of mass, the building shall be as light as possible.

As far as possible, the parts of the building should be tied together in such a manner that the building acts as one unit.

Projecting parts shall be avoided as far as possible. If the projecting parts cannot be avoided, they shall be properly reinforced and firmly tied to the main structure and their design shall be in accordance with IS 1893: 2002.

Buildings having plans with shapes like L – T – E – Y shall preferably be separated into rectangular parts by providing separation sections at appropriate places.

Structures shall not be founded on loose soils which will subside during an earthquake.

2.5 University Question Papers

Code No: R09220106

R09

Set No. 2

II B.Tech II Semester Examinations, APRIL 2011
BUILDING MATERIALS, CONSTRUCTION AND PLANNING

Civil Engineering

Time: 3 hours

Max Marks: 75

Answer any FIVE Questions
All Questions carry equal marks
?????

1. Describe the geological classification of rocks. Give example of each type? [15]
2. Describe various types of paints, and their suitability or use? [15]
3. Explain in detail various systems of mechanical ventilation. [15]
4. Describe in brief any type of manufacture of cement with the help of flow diagram? [15]
5. What do you understand by the term decay OF timber? What are common causes of decay of timber? [15]
6. Explain
 - (a) Flying (or) horizontal shores
 - (b) Dead (or) vertical shores. [7+8]
7. (a) Explain about Internal and external stair ways?
(b) Explain various practical points to be considered while planning a building? [7+8]
8. (a) Explain acid - proofing of floors?
(b) Explain Cement concrete flooring? [7+8]

?????

Code No: R09220106

1

R09

Set No. 4

II B.Tech II Semester Examinations, APRIL 2011
BUILDING MATERIALS, CONSTRUCTION AND PLANNING

Civil Engineering

Time: 3 hours

Max Marks: 75

Answer any FIVE Questions
All Questions carry equal marks

?? ? ? ?

1.(a) Explain about three-coat lime plaster?

(b) Explain various types of composite masonry? [7+8]

2. Write short notes on :

(a) Lean-to-roof.

(b) Couoked roof.

(c) Coupled-close roof.

(d) Collar roof. [15]

3. What are requirements of a good form work? Describe the steps that should be

taken to eect economy in the expenditure on formwork? [15]

4. What do you understand by

(a) ventilation

(b) air conditioning

Explain the necessity of each of them? [15]

What do you understand by the term seasoning of timber? Explain the objects

5. of

Seasoning in detail? [15]

6.(a) Describe various reasons of the decay of stones?

(b) Explain the characteristics of gneiss and laterate? [7+8]

7. Explain about dierent mineral admixtures? [15]

8.(a) Explain the requirements for lighting and ventilation in kitchens and living rooms of a residential building?

(b) Describe about Site plans and building plans. [8+7]

?? ? ? ?

Code No: R09220106

R09

Set No. 1

II B.Tech II Semester Examinations, APRIL 2011
BUILDING MATERIALS, CONSTRUCTION AND PLANNING
Civil Engineering

Time: 3 hours

Max Marks: 75

Answer any FIVE Questions
All Questions carry equal marks

?????

1. What is air conditioning? Discuss in the requirements of Air conditioning. [15]
2. (a) Explain various types of plaster nishes?
(b) Explain header bond in brick masonry? [7+8]
3. Explain, with the help of neat sketches different types of foundations? [15]
4. Write short notes on :
 - (a) Tempering.
 - (b) Frog.
 - (c) Grounded - Moulded Bricks.
 - (d) Tunnel Kiln. [15]
5. What are the various methods of seasoning timber? Explain in detail? [15]
6. Explain the requirements for the following elements of a residential house. What is occupancy of building? Explain how the buildings are classified according to occupancy of building? [15]
7. Write short notes on:
 - (a) Flying shore
 - (b) Horizontal shores
 - (c) Cleaning and surface treatment of shuttering. [15]
8. (a) Explain Bogue's compounds?
(b) Explain why gypsum is added during the manufacture of cement? [7+8]

Code No: R09220106

R09

Set No. 3

II B.Tech II Semester Examinations, APRIL 2011

BUILDING MATERIALS, CONSTRUCTION AND PLANNING

Civil Engineering

Time: 3 hours

Max Marks: 75

Answer any FIVE Questions
All Questions carry equal marks

?? ? ? ?

1.Explain in detail various characteristics of sound as applicable to the acoustic design of a room. What are the standards? [15]
Describe the working of any intermittent kiln known to you with the help of a

2.neat

Sketches? [15]

3.(a) Explain various practical points to be considered while planning a building.

(b) Explain about oor area ratio. [8+7]

4.Explain in detail the process of manufacturing glass? [15]

5.Describe

(a)Flying shore

(b)Tubular scaolding

(c) Form work for square and round columns. [15]

6.Write short note on the following:

(a)Wooden stairs

(b)R.C.C.Stairs.

(c) Spiral stairs. [15]

7.(a) What do you understand by modular bricks?

(b)Draw sketches for the following bricks :

i.Bull Nose Brick

ii.Cant brick

iii.Plinth header

iv. Plith stretcher. [15]

8.(a) What are air entraining agents? How these air entraining agents help in improvig performance of cement?

(b) Explain why gypsum is added during the manufacture of cement? [7+8]

2.6 Question Bank:

Questions in Unit – I from previous question papers

1. Write Short notes on:

- a) Tempering b) Frog c) Grounded – Moulded Bricks
- d) Tunnel Kiln
2. Describe the **geological classification of rocks**. Give example of each type?
2. Describe the working of any **Intermittent Kiln** known to you with the help of a neat sketches ?
3. Answer the following: (a) What do you understand by **modular bricks**?
- b) **Draw sketches** for the following bricks:
 - i) Bull Nose Brick ii) Cant Brick
 - iii) Plinth header iv) Plinth Stretcher
- 4.a) Describe various reasons of the **decay of stones**?
- b) Explain the **characteristics of Gneiss and Laterite**?

2.7 Unit wise objective questions:

OBJECTIVE QUESTIONS

1. In a mortar, the binding material is
 - A. cement
 - B. sand
 - C. surkhi
 - D. cinder.

2. Lacquer paints
 - A. are generally applied on structural steel
 - B. are less durable as compared to enamel paints
 - C. consist of resin and nitro-cellulose
 - D. contain alcohol as thinner
 - E. all the above.

3. Wrought iron contains carbon upto
 - A. 0.25%
 - B. 1.0%
 - C. 1.5%
 - D. 2%.

4. Pick up the polyminerallitic rock from the following:
 - A. Quartz sand

- B.** Pure gypsum
- C.** Magnesite
- D.** Granite
- E.** None of these.

5. Pick up the correct statement from the following:

- A.** For thin structures subjected to wetting and drying, the water cement ratio should be 0.45
- B.** For mass concrete structures subjected to wetting and drying, the water ratio should be 0.55
- C.** For thin structures which remain continuously under water, the water-cement ratio by weight should be 0.55
- D.** For massive concrete structures which remain continuously under water, the water cement ratio by weight should be 0.65
- E.** All the above.

6. Ultimate strength to cement is provided by

- A.** Tricalcium silicate
- B.** Di-calcium silicate
- C.** Tri-calcium aluminate
- D.** Tetra calcium alumino ferrite.

7. Elastomers can extend upto

- A.** five times their original dimensions
- B.** seven times their original dimensions
- C.** ten times their original dimensions
- D.** three times their original dimensions.

8. Bitumen felt

- A.** is used as water proofing material

- B.** is used as damp proofing material
- C.** is made from bitumen and hessian fibres
- D.** all the above.

9. In the method of condensation polymerization,

- A.** low-molecular substances are removed from the high molecular substance
- B.** the reaction proceeds with an evolution of ammonia
- C.** the reaction proceeds with an evolution of hydrogen chloride
- D.** all the above.

10. In the cement the compound quickest to react with water, is

- A.** Tricalcium aluminate
- B.** Tetra-calcium alumino-ferrite
- C.** Tricalcium silicate
- D.** Dicalcium silicate.

11. The initial setting time of lime-pozzolona, is

- A.** 30 minutes
- B.** 60 minutes
- C.** 90 minutes
- D.** 120 minutes.

12. The clay to be used for manufacturing bricks for a large project, is dug out and allowed to weather throughout

- A.** the monsoon
- B.** the winter

- C. the summer
- D. none of these.

13. The rocks which are formed due to cooling of magma at a considerable depth from earth's surface are called

- A. Plutonic rocks
- B. Hypabyssal rocks
- C. Volcanic rocks
- D. Igneous rocks.

14. Quartzite is a

- A. metamorphic rock
- B. argillaceous rock
- C. calcareous rock
- D. silicious rock.

15. The variety of pig iron used for manufacture of wrought iron, is

- A. Bessemer pig
- B. Grey or foundry pig
- C. White forge pig
- D. Mottled pig.

16. Sand stone is

- A. sedimentary rock
- B. metamorphic rock
- C. igneous rock
- D. volcanic rock.

17. If the furnace is provided with insufficient fuel at low temperatures, the type of pig iron produced, is called
- A. Bessemer pig
 - B. Grey or foundry pig
 - C. White or forge pig
 - D. Mottled pig.
-
18. Stainless steel contains
- A. 18% of chromium and 8% nickel
 - B. 8% of chromium and 18% of nickel
 - C. 12% of chromium and 36% of nickel
 - D. 36% of chromium and 12% of nickel.
-
19. Pick up the hypabyssal rock from the following:
- A. Granite
 - B. Dolerite
 - C. Basalt
 - D. All the above.
-
20. Depending on the chemical composition and mechanical properties, iron may be classified as
- A. cast iron
 - B. wrought iron
 - C. steel
 - D. all the above
-
21. Wrought iron contains carbon about
- A. 1.5% to 5.5%
 - B. 0.5% to 1.75%
 - C. 0.1% to 0.25%

D. none to these.

22. The main constituent of fly-ash, is

A. aluminium oxide

B. silica

C. ferrous oxide

D. All of these.

23. Bitumen in

A. solid state, is called asphalt

B. semi fluid state, is called mineral tar

C. fluid state, is called petroleum

D. all the above.

24. The plastics made from cellulose resin

A. are as clear as glass

B. are tough and strong

C. possess excellent electrical properties

D. All the above.

25. Kaolin is chemically classified as

A. metamorphic rock

B. argillaceous rock

C. calcareous rock

D. silicious rock

26. Which one of the following is acid resistant asbestos:

- A. actinolite asbestos
 - B. amosite asbestos
 - C. anthophyllite asbestos
 - D. crocidolite asbestos
 - E. All the above.
-

27. Due to attack of dry rot, the timber

- A. cracks
 - B. shrinks
 - C. reduces to powder
 - D. none of these.
-

28. Brittleness of cold is due to an excess of

- A. sulphur
 - B. carbon
 - C. phosphorus
 - D. silicon.
-

29. For the manufacture of Portland cement, the proportions of raw materials used, are

- A. lime 63% ; silica 22% ; other ingredients 15%
 - B. lime 22% ; silica 63% ; other ingredients 15%
 - C. silica 40% ; lime 40% ; other ingredients 20%
 - D. silica 70% ; lime 20% ; other ingredients 10%.
-

30. Asbestos cement

- A. is brittle
- B. warps due to changes in humidity

- C. strength is lowered when saturated by water
- D. all the above.

31. Gneiss is obtained from

- A. igneous rocks
- B. metamorphic rocks
- C. sedimentary rocks
- D. sedimentary metamorphic rocks.

32. The rocks formed by gradual deposition, are called

- A. sedimentary rocks
- B. igneous rocks
- C. metamorphic rocks
- D. none of these.

33. Galvanising means covering iron with a thin coat of

- A. tin
- B. zinc
- C. glaze
- D. coal tar.

34. For preparing porcelains, the clay should be

- A. sufficiently pure
- B. of high degree of tenacity
- C. of good plasticity
- D. All the above.

35. Polymerization helps to improve the property of

- A. strength
- B. rigidity
- C. elasticity
- D. all of these.

36. Good quality stones must

- A. be durable
- B. be free from clay
- C. resist action of acids
- D. all the above.

37. Sewer pipes are made of

- A. earthen ware
- B. stone ware
- C. refractory clay
- D. terracota
- E. all the above.

38. Fibre glass

- A. retains heat-longer
- B. has a higher strength to weight ratio
- C. is shock proof and fire retardent
- D. does not decay
- E. all the above.

39. Pick up the correct statement from the following:

- A. The theory of formation of concrete is based on the phenomena of formation of voids
- B. The bulking of sand is taken into account while volumetric proportioning of the aggregates

- C.** The dry sand and the sand completely flooded with water, have practically the same volume
 - D.** The expansion and contraction joints are provided if concrete structures exceed 12 m in length
 - E.** All the above.
-

40. Pick up the correct statement from the following:

- A.** In stone arches, the stones are placed with their natural beds radial
- B.** In cornices, the stones are placed with their natural beds as vertical
- C.** In stone walls, the stones are placed with their natural beds as horizontal
- D.** All the above.

41. The commonly used colour pigment in paints, is

- A.** ambers
- B.** carbon black
- C.** iron oxide
- D.** lamp black
- E.** all the above.

42. Varnish is a transparent or semi-transparent solution of resinuous substances in

- A.** alcohol
- B.** linseed
- C.** turpentine
- D.** all the above.

43. Initial setting time of cement for asbestos cement products should be not less than

- A.** 30 minutes
- B.** 50 minutes
- C.** 75 minutes

D. 90 minutes.

44. The variety of pig iron used for the manufacture of steel by Bessemer process, is

- A.** Bessemer pig
 - B.** Grey pig
 - C.** White forge pig
 - D.** Mottled pig.
-

45. For melting one tonne of cast iron

- A.** 700 m³ air is required
 - B.** 20 kg limestone is required
 - C.** one quintal coke is required
 - D.** all the above.
-

46. For filling cracks in masonry structures, the type of bitumen used, is

- A.** cut-back bitumen
 - B.** bitumen-emulsion
 - C.** blown bitumen
 - D.** plastic bitumen.
-

47. Plastic

- A.** is an organic substance
 - B.** consists of natural or synthetic binders
 - C.** finished products are rigid and stable at normal temperature
 - D.** is capable of flow when necessary heat and pressure are applied
 - E.** All the above.
-

48. Vanadium steel is generally used for

- A.** railway switches and crossing

- B. bearing balls
- C. magnets
- D. axles and springs.

49. Pick up the correct statement from the following:

- A. In basic Bessemer process, the steel heats the converter
- B. In open-hearth process, the furnace heats the steel
- C. In Siemens process, the impurities of pig iron are oxidised by the oxygen of the ore
- D. all the above.

50. The process of manufacturing steel by heating short lengths of wrought iron bars mixed with charcoal in fire clay crucibles and collecting the molten iron into moulds, is known as

- A. Cementation process
- B. Crucible process
- C. Bessemer process
- D. Open hearth process

2.8 References, Websites and E links:

Sources of Information

2.8.1. Text books:-

1. R.Chudly “Construction Technology “– Volumes I and II” 2nd Edition, Longman, UK, 1987.
2. Building materials by P.C. Varghese, Prentice-Hall of India private Ltd, New Delhi.

2 P. C. Varghese (2005), Building materials, Prentice Hall of India private Ltd, New Delhi, India.

2.8.2. Reference Text Books:-

1. Building material by S K Duggal – New Age International Publishers; Second Edition
2. Building Construction by B.C.Punmia, Ashok Kumar Jain and Arun Kumar Jain - Laxmi Publications (P) ltd., New Delhi
3. Building Construction by P.C. Varghese, Prentice-Hall of India private Ltd, New Delhi

2 P. C. Varghese (2007), Building Construction, Prentice-Hall of India private Ltd, New Delhi, India.

3 S. K. Duggal (2008), Building material Second Edition, New Age International Publishers, New Delhi, India.

2.8.3 Websites:-

NPTEL Resources

2.9 Quality measurement sheet

EVALUATION SCHEME:

PARTICULAR	WEIGHTAGE	MARKS
End Examinations	75%	75
Three Sessionals	20%	20
Assignment	5%	5
TEACHER'S ASSESSMENT(TA)*	WEIGHTAGE	MARKS

*TA will be based on the Assignments given, Unit test Performances and Attendance in the class for a particular student.



GEETHANJALI COLLEGE OF ENGINEERING & TECHNOLOGY

CHEERYAL (V), KEESARA (M), R.R. DIST. 501 301

DEPARTMENT OF CIVIL ENGINEERING

(Name of the Subject /Lab Course): building material construction and planning

(JNTU CODE: A30107)

Programme: UG

Branch: CIVIL ENGINEERING

Version No: 01

Year: II

Updated on:

Semester: I I

No. of pages:

Classification status (Unrestricted/Restricted)

Distribution List:

Prepared by:

1) Name : MD OSM AN GHANI

1) Name: MD OSMAN GHANI

2) Sign. :

2) Sign :

3) Design.: Asst. Professor

3) Design: Asst. Professor

4) Date :

4) Date :

Verified by:

*** For Q.C Only.**

1) Name :

1) Name :

2) Sign :

2) Sign :

3) Design :

3) Design. :

4) Date :

4) Date :

Approved by: (HOD)

1) Name : Dr. R. RAVI VARMA

2) Sign :

3) Date :

2.9.1 Student List:

S. No	Roll No	Student Name
1	14R11A0149	A. SRAVAN KUMAR
2	14R11A0150	B MAHENDRA VARDHAN
3	14R11A0151	B. VIJAY
4	14R11A0152	B. KIRAN KUMAR
5	14R11A0153	B. SUNIL NAIK
6	14R11A0154	D. VENU CHARY
7	14R11A0155	D. VASANTHA KUMAR
8	14R11A0157	G. NIKHIL
9	14R11A0158	G. SANDEEP KUMAR
10	14R11A0159	G. CHARAN KUMAR
11	14R11A0160	J. HARISH KUMAR
12	14R11A0161	K.J. NANDEESHWAR
13	14R11A0162	K. SANTHOSH KUMAR
14	14R11A0163	K BHARATH KUMAR
15	14R11A0164	K ABHILASH
16	14R11A0165	K SAI KRISHNA
17	14R11A0168	MOHD. ABBAS
18	14R11A0169	M SRINIVAS
19	14R11A0170	N SANTHOSH
20	14R11A0172	OSA NITHISH
21	14R11A0173	P INDRA TEJA
22	14R11A0174	P NAVEEN KUMAR
23	14R11A0175	P BHARATH NARSIMHA REDDY
24	14R11A0176	P SURENDER
25	14R11A0177	R VIHARI PRAKASH
26	14R11A0178	S BHANU KISHORE
27	14R11A0179	SHAILESH KUMAR SINGH
28	14R11A0180	SYED OMER ASHRAF
29	14R11A0181	V SAI SHARATH
30	14R11A0182	Y VENKATA MOHAN REDDY

2.9.2 Group wise student list for discussion topic

S. No	Group No	Roll No	Student Name
1	1	14R11A0149	A. SRAVAN KUMAR
2	1	14R11A0150	B MAHENDRA VARDHAN
3	1	14R11A0151	B. VIJAY
4	1	14R11A0152	B. KIRAN KUMAR
5	1	14R11A0153	B. SUNIL NAIK
6	1	14R11A0154	D. VENU CHARY
7	2	14R11A0155	D. VASANTHA KUMAR
8	2	14R11A0157	G. NIKHIL
9	2	14R11A0158	G. SANDEEP KUMAR
10	2	14R11A0159	G. CHARAN KUMAR
11	2	14R11A0160	J. HARISH KUMAR
12	2	14R11A0161	K.J. NANDEESHWAR
13	3	14R11A0162	K. SANTHOSH KUMAR
14	3	14R11A0163	K BHARATH KUMAR
15	3	14R11A0164	K ABHILASH
16	3	14R11A0165	K SAI KRISHNA
17	3	14R11A0168	MOHD. ABBAS
18	3	14R11A0169	M SRINIVAS
19	4	14R11A0170	N SANTHOSH
20	4	14R11A0172	OSA NITHISH
21	4	14R11A0173	P INDRA TEJA
22	4	14R11A0174	P NAVEEN KUMAR
23	4	14R11A0175	P BHARATH NARSIMHA REDDY
24	4	14R11A0176	P SURENDER
25	5	14R11A0177	R VIHARI PRAKASH
26	5	14R11A0178	S BHANU KISHORE
27	5	14R11A0179	SHAILESH KUMAR SINGH
28	5	14R11A0180	SYED OMER ASHRAF
29	5	14R11A0181	V SAI SHARATH
30	5	14R11A0182	Y VENKATA MOHAN REDDY

GCCEFT