

**VEER SURENDRA SAI UNIVERSITY OF TECHNOLOGY  
BURLA, ODISHA**

**DEPARTMENT OF MECHANICAL ENGINEERING**

**ENGINEERING THERMODYNAMICS**

**Lecture Notes**

## **Disclaimer**

This document does not claim any originality and cannot be used as a substitute for prescribed textbooks. The information presented here is merely a collection by the committee members for their respective teaching assignments. Various sources as mentioned at the reference of the document as well as freely available material from internet were consulted for preparing this document. The ownership of the information lies with the respective authors or institutions. Further, this document is not intended to be used for commercial purpose and the committee members are not accountable for any issues, legal or otherwise, arising out of use of this document. The committee members make no representations or warranties with respect to the accuracy or completeness of the contents of this document and specifically disclaim any implied warranties of merchantability or fitness for a particular purpose. The committee members shall be liable for any loss of profit or any other commercial damages, including but not limited to special, incidental, consequential, or other damages.

# ENGINEERING THERMODYNAMICS

## What is Thermodynamics?

- ❖ Thermodynamics is a science dealing with Energy and its transformation and its effect on the physical properties of substances.
- ❖ It deals with equilibrium and feasibility of a process.
- ❖ Deals with the relationship between heat and work and the properties of systems in equilibrium.

## Scope of Thermodynamics:

- ❖ Steam power plant
- ❖ Separation and Liquification Plant
- ❖ Refrigeration
- ❖ Air-conditioning and Heating Devices.
- ❖ Internal combustion engine
- ❖ Chemical power plants
- ❖ Turbines
- ❖ Compressors, etc

The principles of thermodynamics are summarized in the form of four thermodynamic laws:

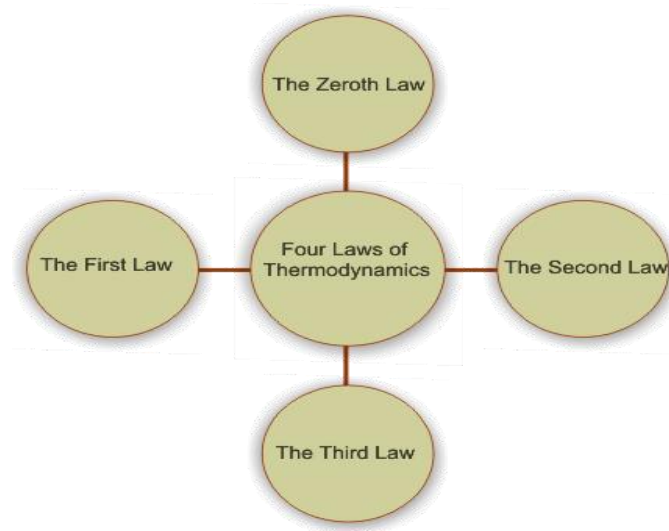

- **The Zeroth Law** deals with thermal equilibrium and provides a means for measuring temperatures.
- **The First Law** deals with the conservation of energy and introduces the concept of internal energy.
- **The Second Law** of thermodynamics provides with the guidelines on the conversion of internal energy of matter into work. It also introduces the concept of entropy.
- **The Third Law** of thermodynamics defines the absolute zero of entropy. The entropy of a pure crystalline substance at absolute zero temperature is zero.

**Different Approaches of Thermodynamics :**

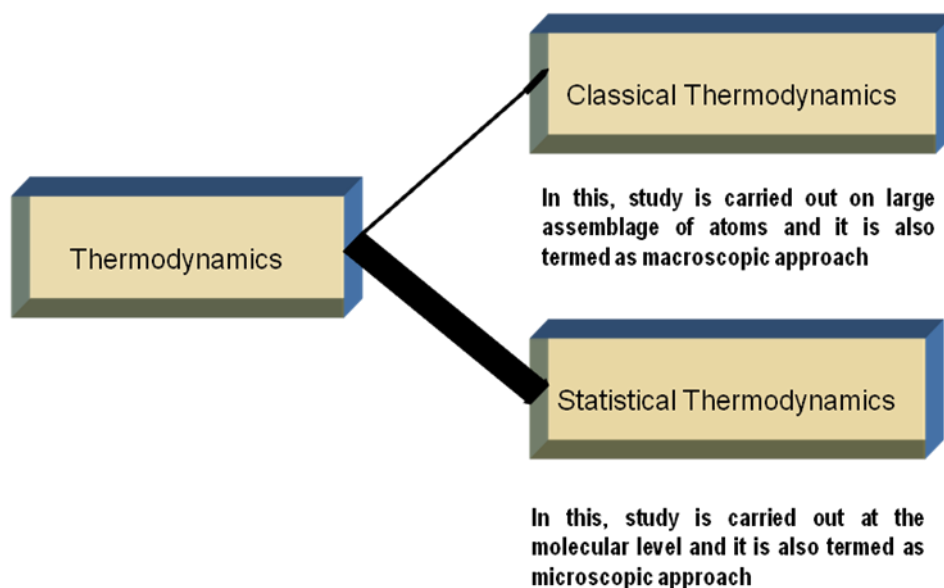

**Write the difference between Macroscopic and Microscopic approach of Thermodynamics:**

<b>Macroscopic Approach</b>	<b>Microscopic Approach</b>
1. Macroscopic approach is known as Classical Thermodynamics.	1. Microscopic approach is known as Statistical Thermodynamics
2. Attention is focussed on a certain quantity of matter without taking into account the events occurring at molecular level.	2. A knowledge of the structure of matter under consideration is essential.

3. Only a few variables are used to describe the state of the matter under consideration.	3. A large no. of variables are required for a complete specification of the state of matter under consideration.
4. The values of the variables used to describe the state of the matter are easily measurable.	4. The variables used to describe the state of matter cannot be measured easily and precisely

### Define Thermodynamic System?

A thermodynamic system is defined as a definite quantity of matter or a region of space within a prescribed boundary upon which attention is focussed in the analysis of a problem.

**Surrounding:** Everything external to the system is Surroundings.

### Boundary:

- The surface which separates the system from the surrounding.
- System and surrounding interact through boundary in the form of Heat and Work.
- Boundary can be real (or) imaginary.
- Boundary can be fixed (or) moving.

System and Surrounding put together is known as **Universe**

### Interaction Between System and Surrounding

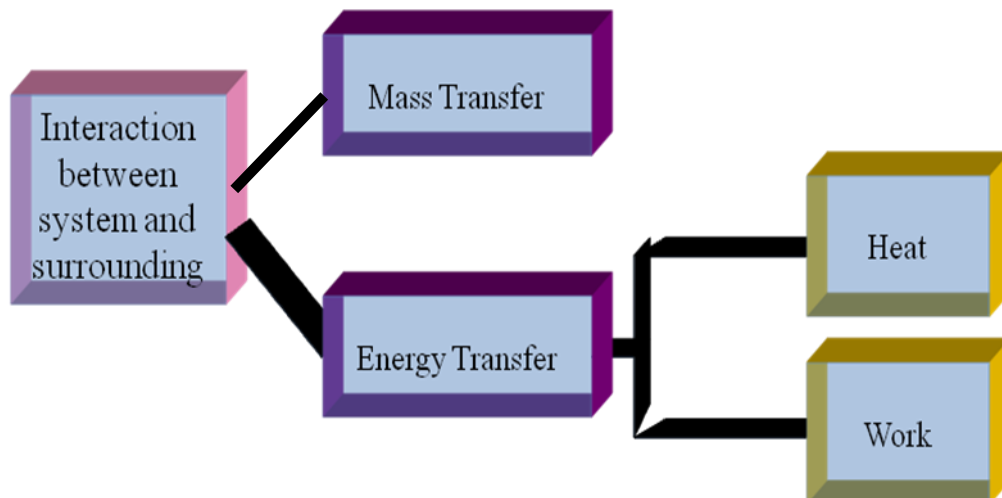

Based on the type of interaction, the systems are classified as

- **CLOSED SYSTEM**
- **OPEN SYSTEM**
- **ISOLATED SYSTEM**

**CLOSED SYSTEM (Control Mass) :** It is also termed as control mass or fixed mass analysis.

There is no mass transfer across the system boundary but energy in the form of Heat or Work can cross the system boundary.

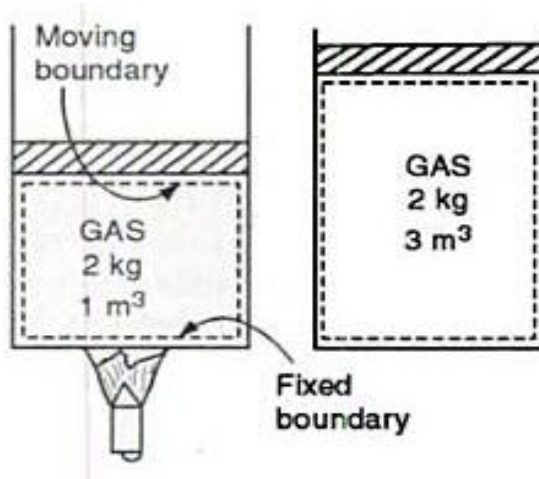

Eg. A certain amount of gas enclosed in a cylinder piston arrangement.

**Open System(Control Volume):** The open system is one in which both mass and energy can cross the boundary of the system.

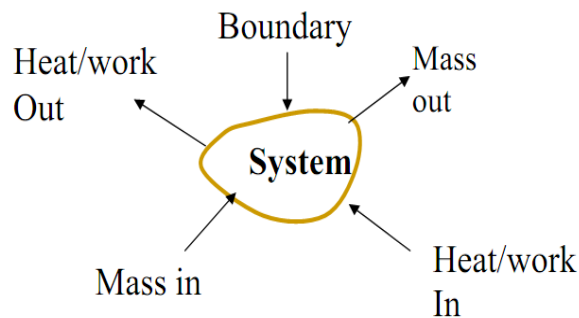

Open system is also termed as control volume analysis.

### Write down the concept of Control Volume:

A large engineering problems involve mass flow in and out of a system and therefore, are modeled as control volumes.

**Control volume** refers to a definite volume on which attention is focussed for energy analysis.

Examples: Nozzles, Diffusers, Turbines, Compressors,

Heat Exchanger, De-superheater, Throttling valves,

I.C engine etc.

**Control Surface:** The closed surface that surrounds the control volume is called **CONTROL SURFACE**. Mass as well as energy crosses the control surface. Control surface can be real or imaginary.

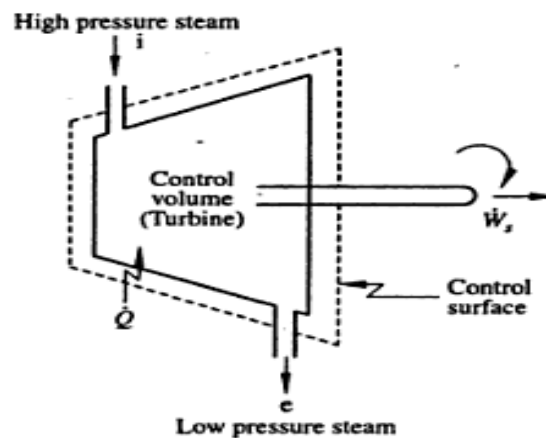

**Isolated System:** The isolated system is one in which there is no interaction between the system and the surroundings that neither the mass nor the energy interactions. Therefore it is of fixed mass and energy.

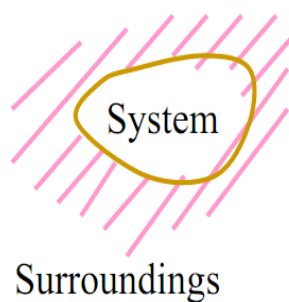

**Note:**

<b>Mass Transfer</b>	<b>Energy Transfer</b>	<b>Type of System</b>
<b>No</b>	<b>Yes</b>	<b>Closed System</b>
<b>Yes</b>	<b>Yes</b>	<b>Open System</b>
<b>No</b>	<b>No</b>	<b>Isolated System</b>
<b>Yes</b>	<b>No</b>	<b>Impossible</b>

**What do you mean by Property?**

Any observable characteristics required to describe the conditions or state of a system is known as Thermodynamic property of a system.

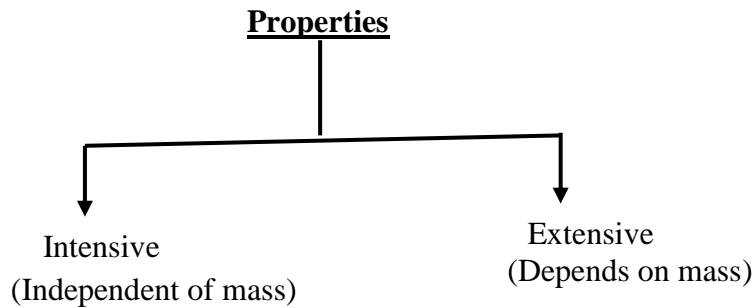

**Differentiate Intensive and Extensive Property?**

<b>Extensive Property</b>	<b>Intensive Property</b>
1. Extensive properties are dependent on the mass of a system.	1. Intensive properties are independent of the mass of a system.
2. Extensive properties are additive.	2. Intensive properties are not additive.



3. Its value for an overall system is the sum of its values for the parts into which the system is divided.	3. Its value remains the same whether one considers the whole system or only a part of it.
4.Example:mass(m),volume(V),Energy(E),Enthalpy(H) etc.	4.Example:Pressure(P),Temperature(T),Density etc.
5. Uppercase letters are used for extensive properties except mass.	5. Lowercase letters are used for intensive properties except pressure(P) and temp.(T)

Specific property= Extensive property/mass.

Example: Specific volume ( $v$ ) = Volume( $V$ )/mass( $m$ )

Specific enthalpy ( $h$ ) = Enthalpy( $H$ )/mass( $m$ )

Specific entropy ( $s$ ) = Entropy( $S$ )/mass( $m$ )

### State:

- It is the condition of a system as defined by the values of all its properties.
- It gives a complete description of the system.
- Any operation in which one or more properties of a system change is called *change of state* .

### Path and Process:

- The series of state through a system passes during a change of state is *Path of the system*.
- If the path followed by the system during change of state is specified or defined completely, then it is called a process.

We can allow one of the properties to remain a constant during a process.

Isothermal  $\Rightarrow$  Constant Temperature ( $T$ )

Isobaric  $\Rightarrow$  Constant Pressure ( $P$ )

Isochoric  $\Rightarrow$  Constant Volume ( $V$ )

Isentropic  $\Rightarrow$  Constant Entropy ( $s$ )

Isenthalpic  $\Rightarrow$  Constant Enthalpy ( $h$ )

**Cycle:** When a system in a given initial state undergoes a series of processes and returns to initial state at the end of process, then the system is said to have undergone a thermodynamic cycle.

**DIFFERENTIATE BETWEEN POINT FUNCTION VS PATH FUNCTION**

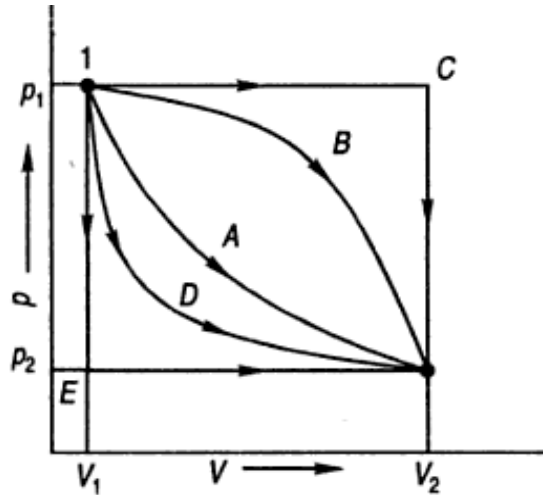

Point Function	Path Function
1. Any quantity whose change is independent of the path is known as point function.	1. Any quantity, the value of which depends on the path followed during a change of state is known as path function.
2. The magnitude of such quantity in a process depends on the state.	2. The magnitude of such quantity in a process is equal to the area under the curve on a property diagram.
3. These are exact differential.	3. These are inexact differential. Inexact differential is denoted by $\delta$
4. Properties are the examples of point function like pressure(P), volume(V), Temp.(T), Energy etc.	4. Ex: Heat and work

## Thermodynamic Equilibrium

A system is said to exist in a state of Thermodynamic Equilibrium when no changes in macroscopic property is observed if the system is isolated from its surrounding.

At the state of equilibrium, the properties of the system are uniform and only one value can be assigned to it.

A system will be in a state of thermodynamic equilibrium, if the condition for following three types of equilibrium are satisfied.

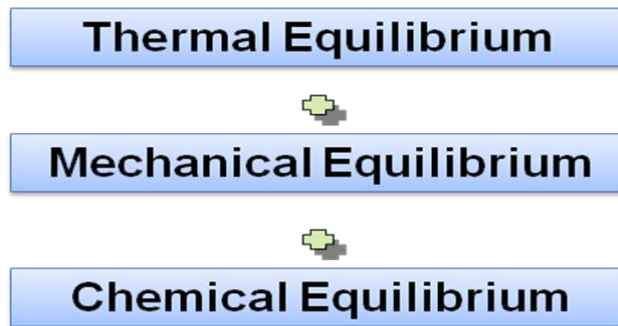

### Thermal Equilibrium (Equality of Temperature):

A state of thermal equilibrium can be described as one in which the temperature of the system is uniform.

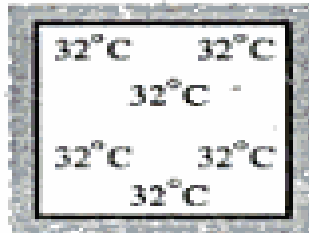

### Mechanical Equilibrium(Equality of Pressure):

In the absence of any unbalanced force within the system itself and also between the system and the surroundings, the system is said to be in a state of mechanical equilibrium.

- Mechanical equilibrium is related to pressure.
- A system is in mechanical equilibrium if there is no change in pressure at any point of the system .

## Chemical Equilibrium(Equality of chemical potential):

- A system is in chemical equilibrium when its chemical composition does not change with time, that is no chemical reaction occurs .
- It is related to chemical potential.

## QUASI-STATIC PROCESS

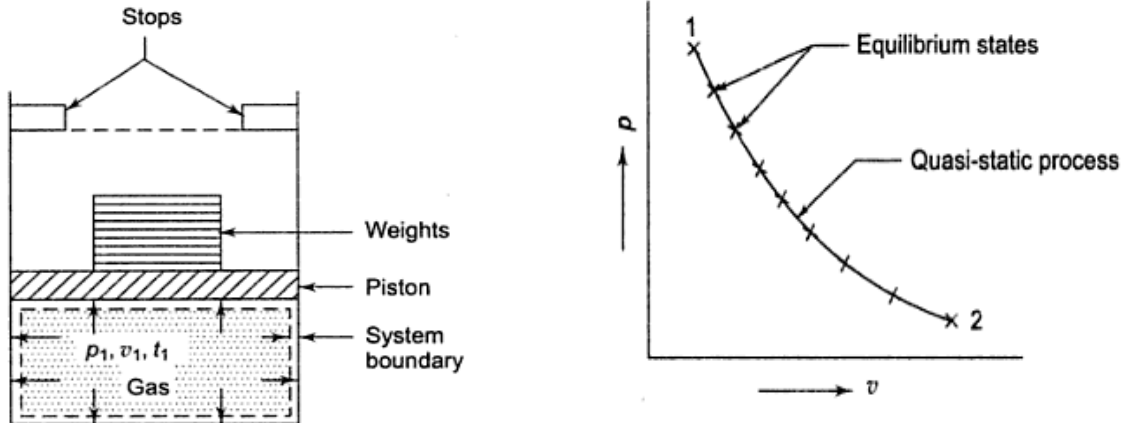

A quasi-static process is one in which the deviation from thermodynamic equilibrium is infinitesimal.

### Characteristics:

- Infinite slowness is the characteristic feature of this process.
- A quasi-static process is thus a *succession of equilibrium states*.
- It can be represented as a continuous line on the property diagram.
- It is also known as a reversible process.

## REVERSIBLE PROCESS

Reversible process is one which is performed in such a way that at the end of the process both the system and surrounding may be restored to their initial state without producing any changes in rest of the Universe.

### Reasons for studying Reversible Process:

- 1.They are easy to analyze.

2. They served as an idealized process to which actual process can be compared.
3. They are taken for consideration because work producing devices such as steam turbine, automobile engines etc delivers the max. work and work consuming devices like compressors, pumps etc consumes the least work.

### **Characteristics of Reversible Process**

- ✓ A Reversible process is carried out infinitely slowly with an infinitesimal gradient so that every state pass through by the system is in equilibrium.
- ✓ It is possible to execute the process in either of the direction.
- ✓ No dissipative effect such as friction, loss in a resistor, etc are present.
- ✓ Heat and work interactions of the system and the surroundings in the reverse process are equal and opposite in direction to the same in the forward process.

### **Examples:**

1. Frictionless isothermal expansion or compression of a fluid.
2. Frictionless adiabatic expansion or compression of a fluid.
3. Elastic stretching of a solid.
4. Electric current with zero resistance.

### **IRREVERSIBLE PROCESS**

An irreversible process is one that is carried out in such a way that the system and surrounding can not be exactly restored to their respective initial state at the end of the reverse process, that a net change occurs in the Universe.

**Note:** In an irreversible the surrounding would always be affected by loss of work and gain of low temperature heat, which can be considered as waste heat for the surrounding.

### **Causes of an Irreversibility:**

The irreversibility of a process may be due to either one or both of the following.

- (i) Lack of Equilibrium.
- (ii) Involvement of Dissipative effects.

### **Lack of Equilibrium(Mechanical,Thermal,Chemical)**

The lack of equilibrium between the system and the surroundings or between the two systems causes a spontaneous change which makes the process irreversible.

#### **Examples:**

1. Heat transfer through a finite temperature difference.
2. Compression or Expansion through a finite pressure difference between the system and the surroundings.
3. Free expansion or Unrestrained expansion.
4. Mixing of substances.

#### **Dissipative Effects:**

Dissipation results in the transformation of work into molecular energy of the system.

#### **Examples:**

1. Friction.
2. Flow of electricity through a resistor.
3. Paddle wheel work transfer. etc

#### **Characteristics of an Irreversible Process:**

1. It can be carried out in one direction only.
2. It occurs at a finite rate.
3. During an irreversible process, the system is not in equilibrium.

An irreversible process cannot be reversed without causing permanent changes in the surroundings.

## Heat & Work Transfer

**Thermodynamic Work:** Work is said to be done by a system if the sole effect on things external to the system can be reduced to the raising of a weight.

**Displacement (or) pdV Work:**

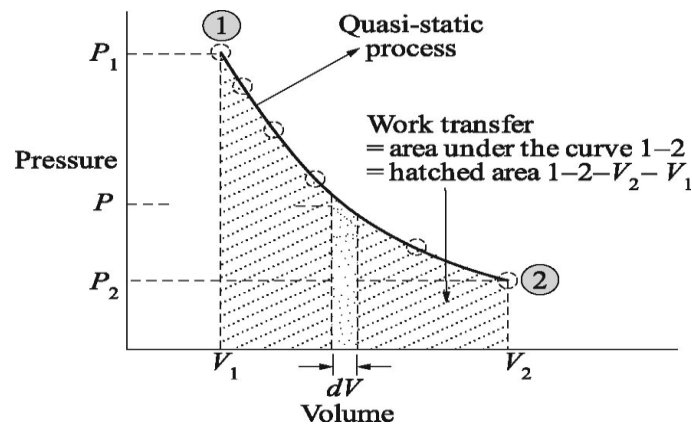
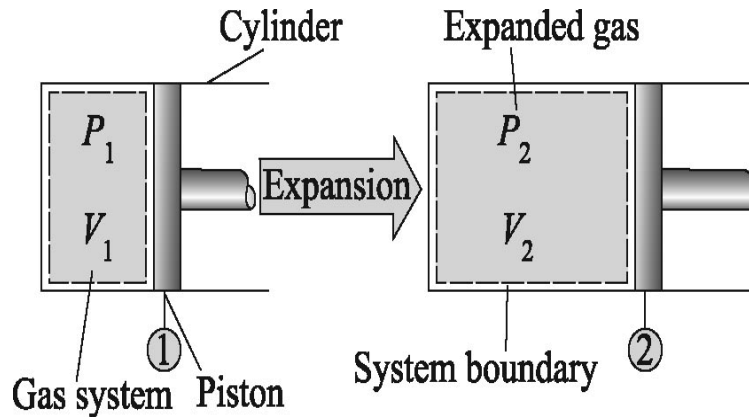

**Expression for pdV Work:**

$$\begin{aligned} W &= \int dW \\ &= \int (p * \text{piston area} * \text{displacement}) \\ &= \int p * A * dL \\ &= \int p dV \\ W_{12} &= \int_1^2 p dV \end{aligned}$$

### Sign Convention for work transfer:

Work done by the system is **positive** and Work done on the system is **negative**.

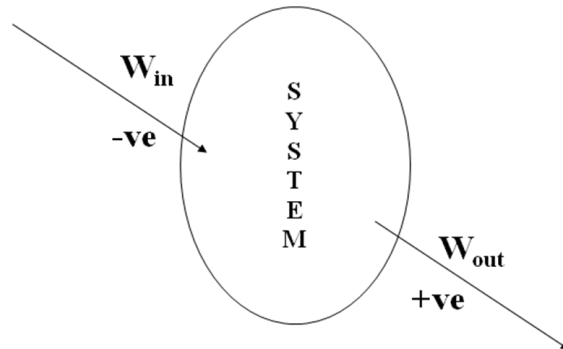

### Work done during various Quasi-static Processes:

Constant Pressure Process:

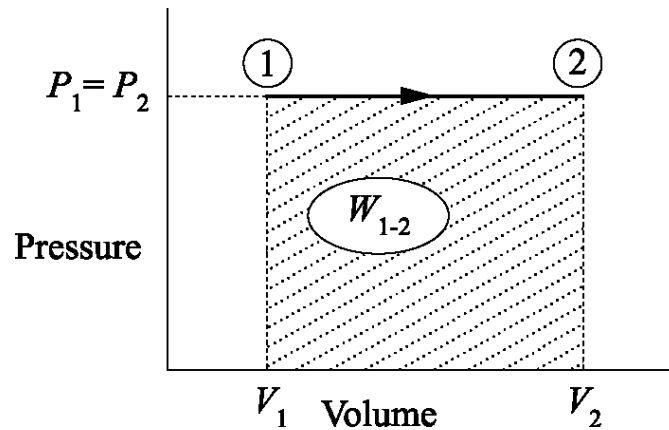

$$W_{1-2} = \int_{V_1}^{V_2} p dV = p(V_2 - V_1)$$

Constant Volume Process:

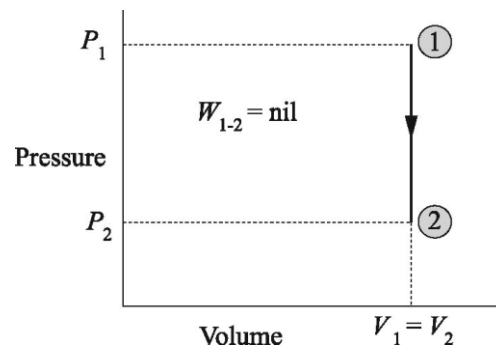



$$W_{1-2} = \int_{V_1}^{V_2} p dV = 0$$

**Constant Temperature Process:**

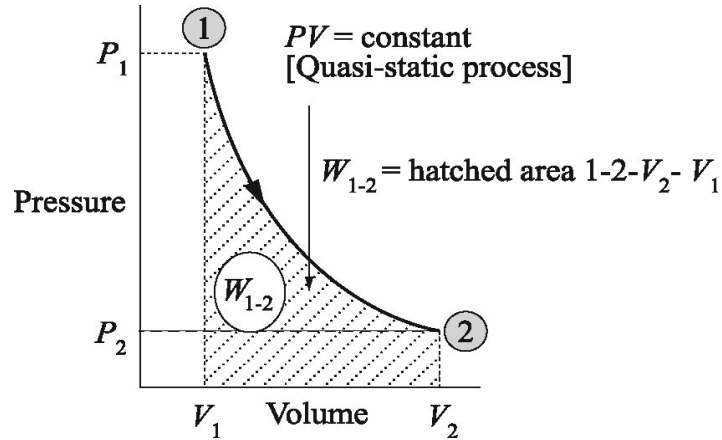

$$W_{1-2} = \int_{V_1}^{V_2} p dV$$

$$pV = p_1V_1 = C$$

$$p = \frac{p_1V_1}{V}$$

$$W_{1-2} = p_1V_1 \int_{V_1}^{V_2} \frac{dV}{V} = p_1V_1 \ln \frac{V_2}{V_1}$$

**Polytropic Process**  $pV^n = C$ , where  $n$  is a constant

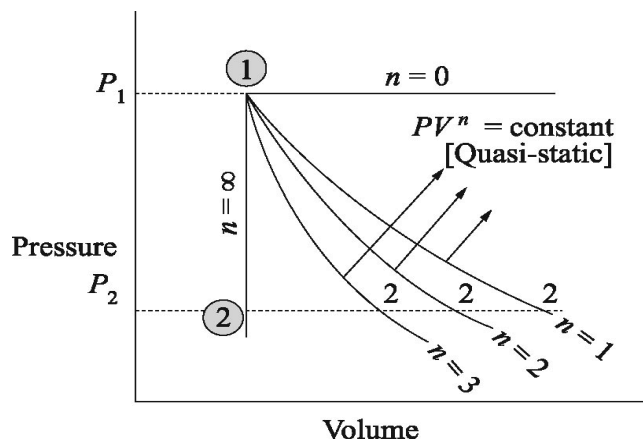

$$pV^n = p_1V_1^n = p_2V_2^n = C$$

$$p = \frac{(p_1V_1^n)}{V^n}$$

$$\begin{aligned} W_{1-2} &= \int_{V_1}^{V_2} p dV \\ &= \int_{V_1}^{V_2} \frac{p_1V_1^n}{V^n} dV \\ &= \frac{p_1V_1 - p_2V_2}{n-1} \end{aligned}$$

**Heat Transfer:** Energy transfer by virtue of temperature difference is called Heat Transfer. Heat Transfer is also a boundary phenomenon.

**Specific Heat:** It is the amount of heat required to raise the temperature of unit mass of a substance by unit degree.

For **Solids** and **Liquids**

$$c_p = c_v = c$$

For **Gases**

$c_p$  – specific heat capacity at constant pressure

$c_v$  – specific heat capacity at constant volume

**Latent Heat:** It is the amount of heat transferred to cause a phase change.

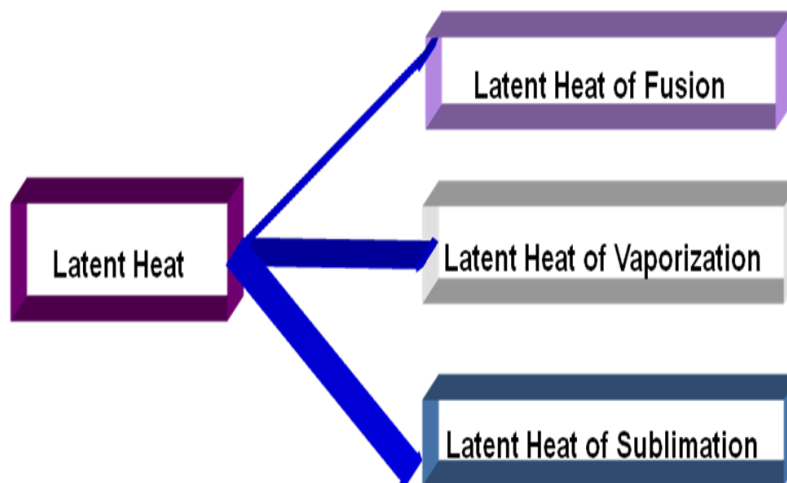

## FIRST LAW OF THERMODYNAMICS

- This is based on Law of Conservation of Energy.
- This is also called as First Principle.

### For a closed system, undergoing a cycle

Sum of all Work transfers = Sum of all Heat Transfers

$$(W_1+W_2+W_3+\dots) = \Sigma(Q_1 + Q_2+Q_3+\dots\dots\dots)$$

$$\Sigma(W) = \Sigma(Q)$$

$$\oint dW = \oint dQ$$

### For a closed system,undergoing a Process

Whenever heat is absorbed by a system it increases its internal energy and does some work.

$$Q = \Delta E + W$$

- Where
- Q – heat absorbed by the system
  - W – Work output from the system
  - $\Delta E$  – Change in Stored Energy of the system

### Show that Energy is a property of the system

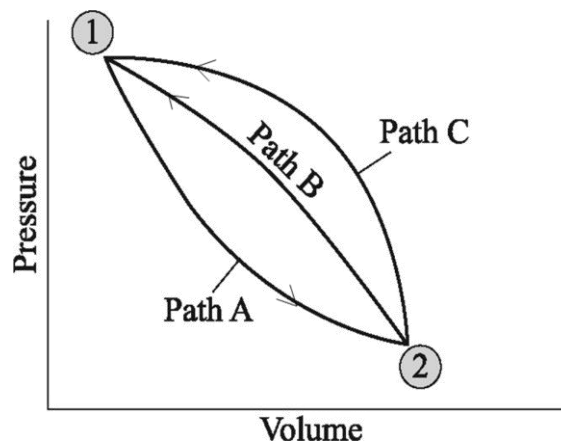

For path A,

$$Q_A = W_A + \Delta E_A \quad (1)$$

For path B,

$$Q_B = W_B + \Delta E_B \quad (2)$$

For path C,

$$Q_C = W_C + \Delta E_C \quad (3)$$

For Cycle 1-A-2-B-1,

$$W_A + W_B = Q_A + Q_B \quad (4)$$

$$Q_A - W_A = -(Q_B - W_B)$$

$$\Delta E_A = -\Delta E_B \quad (A)$$

For Cycle 1-A-2-C-1,

$$W_A + W_C = Q_A + Q_C$$

$$Q_A - W_A = -(Q_C - W_C)$$

$$\Delta E_A = -\Delta E_C \quad (C)$$

Comparing A and C

$$\Delta E_B = \Delta E_C$$

### Enthalpy:

- It is the energy content of the flowing fluid.
- It is defined by the summation of internal energy and flow work.

$$H = U + PV$$

Note: For an ideal gas  $h = u + Pv$ .

$$= u + RT$$

$$\text{So, } h = f(T)$$

### Define $C_v$ with the help internal energy and Temperature:

The amount of heat required to raise the temperature of unit mass of a substance by  $1^\circ \text{C}$  in a reversible constant volume process.

$$C_v = \left( \frac{\partial u}{\partial T} \right)_v$$

$C_v$  is also defined as the change of internal energy of the substance per unit change in temperature at constant volume.

**Define  $C_p$  with the help enthalpy and Temperature:**

The amount of heat required to raise the temperature of unit mass of a substance by 1° C in a reversible constant pressure process.

$$C_p = \left( \frac{\partial h}{\partial T} \right)_p$$

$C_p$  is also defined as the change of internal energy of the substance per unit change in temperature at constant pressure.

**Application of First law to different Thermodynamic process:**

Process	Index=n	Q	$W = \int PdV$	P-V-T Relation
Rev. Const.Vol.	$\infty$	$Q = \Delta U$ $= mC_v(T_2 - T_1)$	$W=0$	$\frac{P_1}{T_1} = \frac{P_2}{T_2}$
Rev.Const.pressure	$n=0$	$Q = \Delta H$ $= mC_p(T_2 - T_1)$	$W = P(V_2 - V_1)$ $= mR(T_2 - T_1)$	$\frac{V_1}{T_1} = \frac{V_2}{T_2}$
Rev. Isothermal	$n=1$	$Q = W = P_1V_1 \ln\left(\frac{V_2}{V_1}\right)$	$W = P_1V_1 \ln\left(\frac{V_2}{V_1}\right)$	$P_1V_1 = P_2V_2$
Rev.Adiabatic	$n=\gamma$	$Q=0$	$W = \frac{P_1V_1 - P_2V_2}{\gamma - 1}$	$P_1V_1^\gamma = P_2V_2^\gamma$
Rev.Polytropic	$n$	$Q = \Delta U + W$	$W = \frac{P_1V_1 - P_2V_2}{n - 1}$	$P_1V_1^n = P_2V_2^n$

## MODULE-2

### SECOND LAW OF THERMODYNAMICS

#### State the limitations of first law of thermodynamics?

1. First Law places no restriction on the direction of a process.
2. It does not ensure whether the process is feasible or not.
3. This law does not differentiate heat and work. It is concerned with the quantity of energy and the transformation of energy from one form to another with no regard to its quality.

#### Aspects of the second law

1. To identify the direction of process.
2. Establishing conditions for equilibrium.
3. It also asserts that energy has quality as well as quantity.
3. It is also used in determining the theoretical limits for the performance of heat engines and refrigerators.
4. Defining a temperature scale independent of the properties of any thermometric substance.

**Thermal Energy Reservoir (TER):** It is a hypothetical body with a relatively large thermal energy capacity that can supply or absorb finite amount of heat without undergoing any change in temperature. Examples: Oceans, rivers, atmospheric air etc.

- TER that supplies energy in the form of heat is called a **source**
- TER that absorbs energy in the form of heat is called a **sink**

**Heat Engines:** Heat engine is a cyclic device, used to convert heat to work. Heat engine can be characterized by the following points.

1. They receive heat from a high temperature source (solar energy, oil-furnace etc.)
2. They convert part of this heat to work (usually in the form of a rotating shaft)
3. They reject the remaining waste heat to a low temperature sink (the atmosphere, rivers, etc)
4. They operate on a cycle.

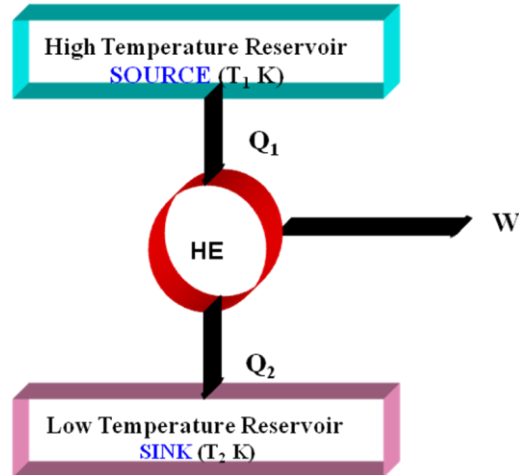

$Q_1$  = amount of heat supplied to steam in boiler from a high-temperature source.

$Q_2$  = amount of heat rejected from steam in condenser to a low temperature sink.

$W$  = net work output of this heat engine.

**Thermal efficiency:** The fraction of the heat input that is converted to net work output is a measure of the performance of the heat engine.

$$\text{Thermal efficiency}(\eta) = \frac{\text{Net work output}}{\text{Total heat input}}$$

$$\eta_{\text{th}} = \frac{W}{Q_1}$$

$$\eta_{\text{th}} = 1 - \frac{Q_2}{Q_1}$$

**Refrigerator:** Refrigerators are cyclic devices, used to transfer heat from a low temperature medium to a high temperature medium.

The working fluid used in the refrigeration cycle is called a refrigerant. The most frequently used refrigeration cycle is the vapor-compression refrigeration cycle.

**Coefficient of Performance (COP)**

$$\text{COP}_R = \frac{\text{Desired output}}{\text{Required input}} = \frac{Q_2}{W}$$

$$\text{COP}_R = \frac{Q_2}{Q_1 - Q_2}$$

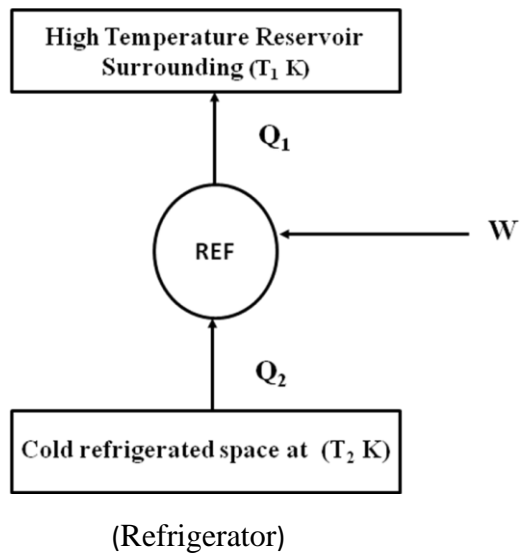

**Heat Pumps:** Heat pumps are another cyclic devices, used to transfer heat from a low temperature medium to a high temperature medium.

The objective of a heat pump is to maintain a heated space at a high temperature. This is accomplished by absorbing heat from a low temperature source, such as cold outside air in winter and supplying this heat to the high temperature medium such as a house.

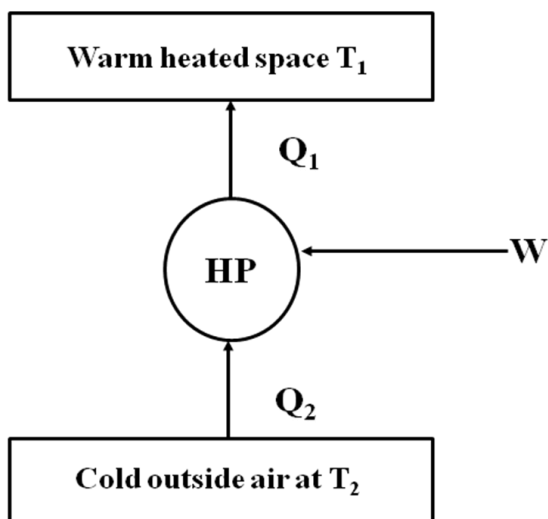

$$\text{COP}_{\text{HP}} = \frac{\text{Desired output}}{\text{Required input}} = \frac{Q_1}{W}$$

$$\text{COP}_{\text{HP}} = \frac{Q_1}{Q_1 - Q_2}$$

Relation between  $\text{COP}_{\text{HP}}$  and  $\text{COP}_{\text{R}}$

$$\text{COP}_{\text{HP}} = \text{COP}_{\text{R}} + 1$$



## Statements of Second Law

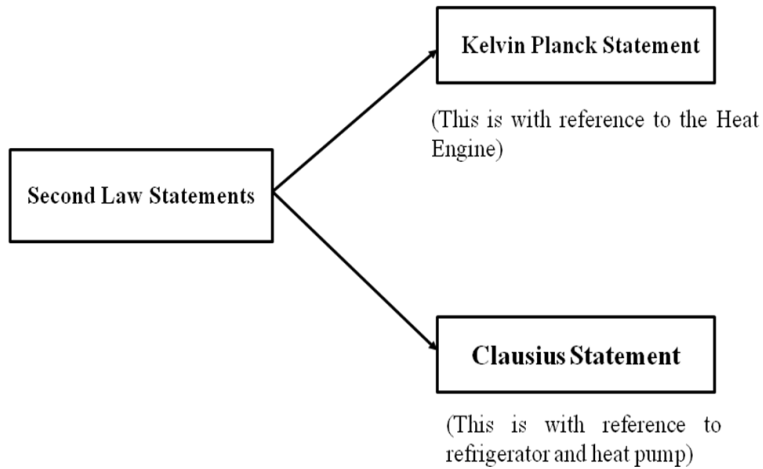

### Kelvin-Planck Statement of the Second law

It is impossible for any device that operates on a cycle to receive heat from a single reservoir and produce a net amount of work.

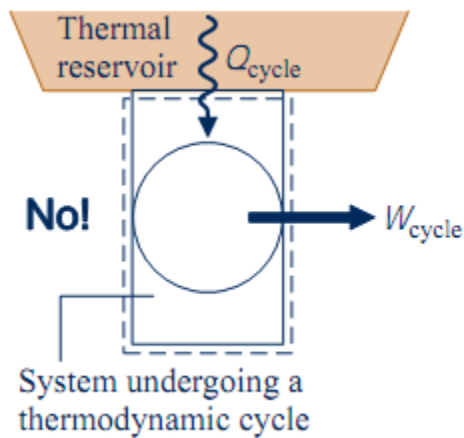

(A heat engine that violates the Kelvin-Planck statement)

### Clausius Statement:

It is impossible to construct a device that operates in a cycle and produce no effect other than the transfer of heat from a low temperature body to a high temperature body.

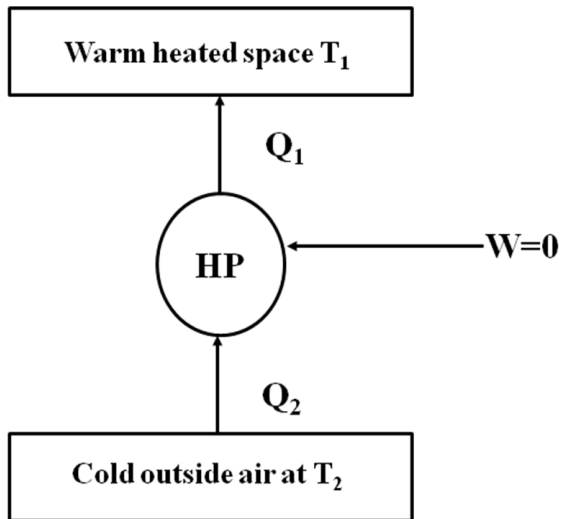

A refrigerator that violates the Clausius statement of the second law

**Equivalence of Kelvin Planck and Clausius Statements:**

The equivalence of the statement is demonstrated by showing that the violation of each statement implies the violation of other.

**CASE-1: Violation of Kelvin-planck statement leads to violation of Clausius statement**

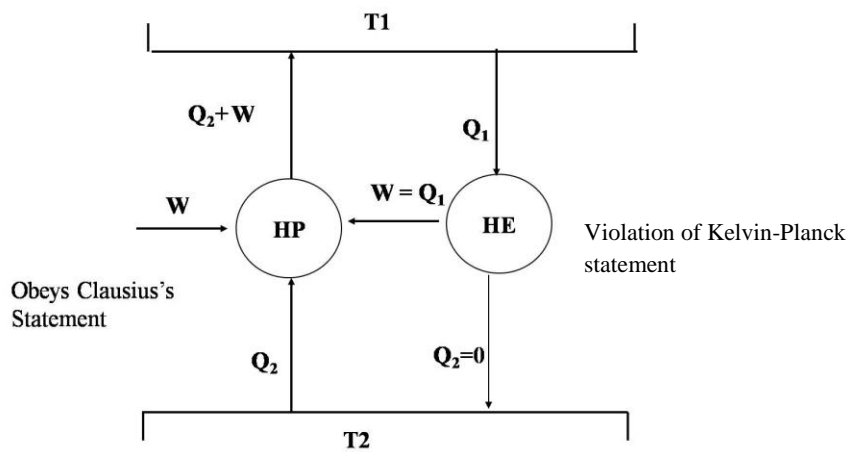

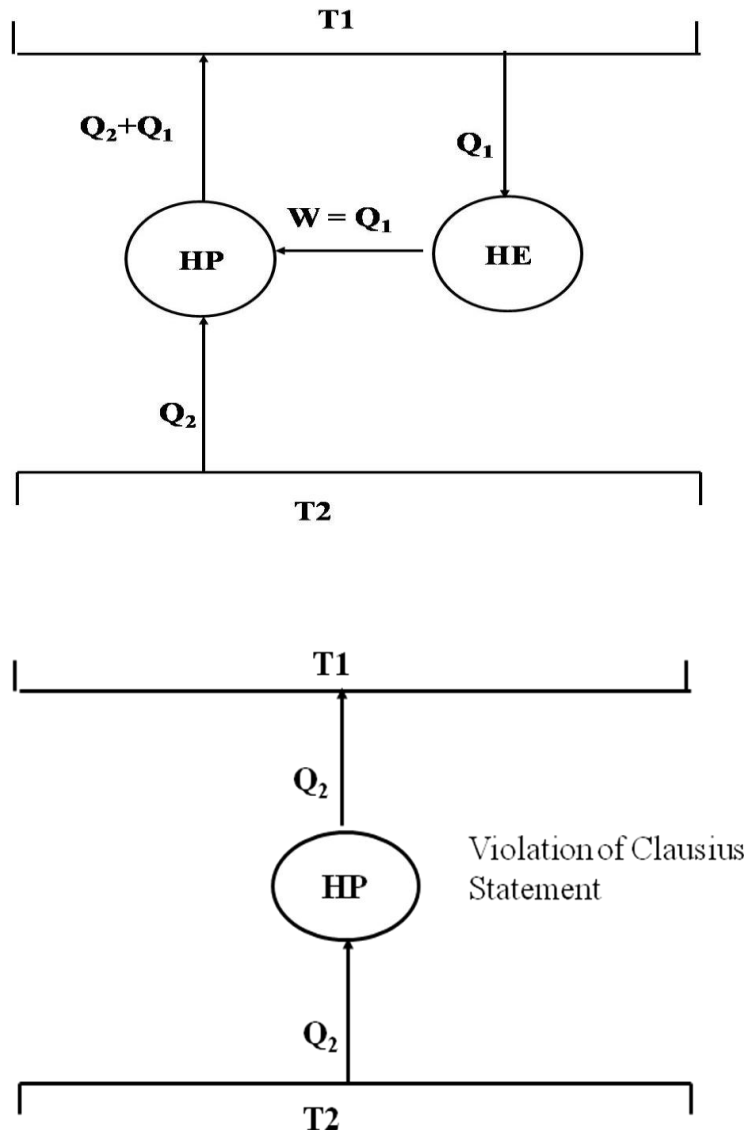

Thus violation Kelvin Planck Statement has lead to the violation of Clausius Statement

**CASE-2: Violation of Clausius statement leads to violation of Kelvin-planck statement**

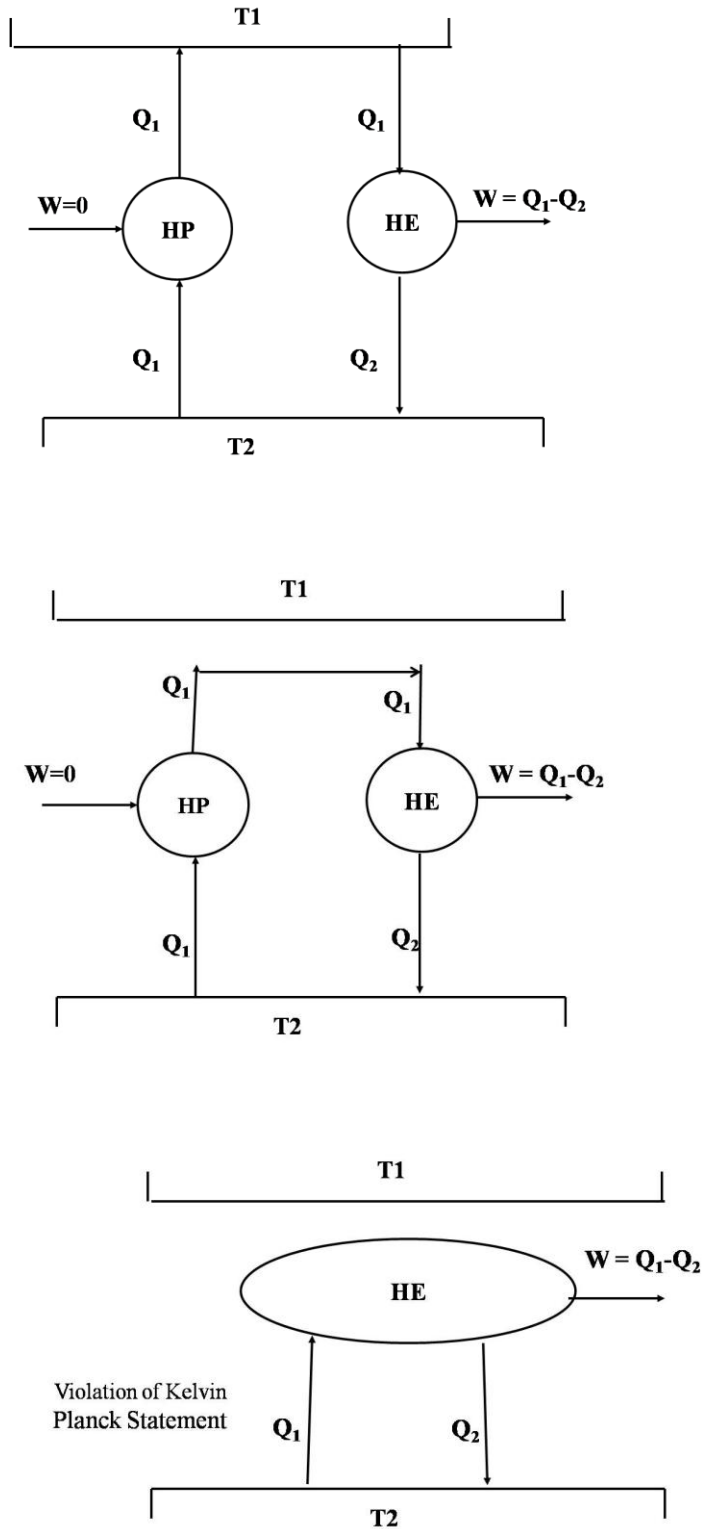

Thus Violation of Clausius Statement has lead to violation of Kelvin Planck Statements

**Carnot Cycle:** Carnot cycle is a reversible cycle that is composed of four reversible processes, two isothermal and two adiabatic.

- **Process 1 - 2 (Reversible Isothermal Heat Addition)**
- **Process 2 - 3 (Reversible Adiabatic Expansion)**
- **Process 3 - 4 (Reversible Isothermal Heat Rejection)**
- **Process 4 - 1 (Reversible Adiabatic Compression)**

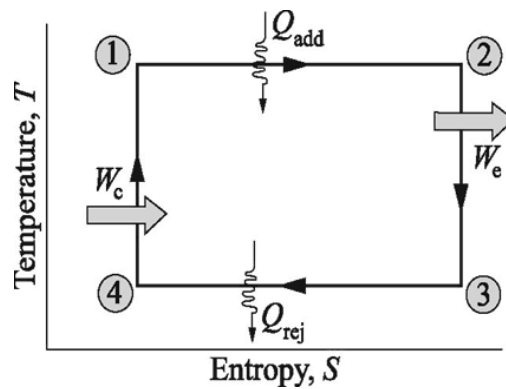
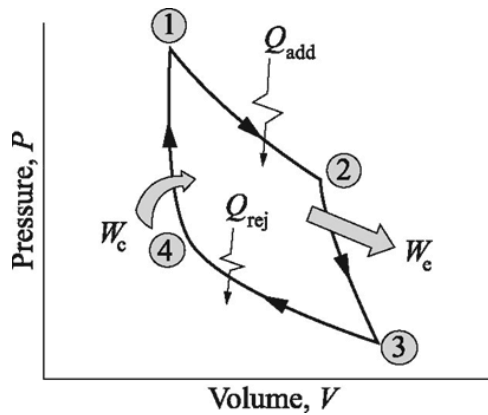

$$\Sigma(Q_{\text{net}})_{\text{cycle}} = \Sigma(W_{\text{net}})_{\text{cycle}}$$

$$Q_{\text{add}} - Q_{\text{rej}} = W_e - W_c$$

$$\eta = \frac{W_{\text{net}}}{Q_{\text{add}}} = \frac{Q_{\text{add}} - Q_{\text{rej}}}{Q_{\text{add}}}$$

$$\eta = 1 - \frac{Q_{\text{rej}}}{Q_{\text{add}}}$$

From T-S diagram

$$\eta = 1 - \frac{T_2 (\Delta S)}{T_1 (\Delta S)}$$

$$\eta = 1 - \frac{T_2}{T_1}$$

### Carnot's Theorem:

1. The efficiency of an irreversible heat engine is always less than efficiency of a reversible one operating between the same two reservoirs.
2. The efficiencies of all reversible heat engines operating between the same reservoirs are the same.

### Clausius Inequality

The cyclic integral of  $\frac{\delta Q}{T}$  is always less than or equal to zero.

Mathematically it can be expressed as  $\oint \frac{\delta Q}{T} \leq 0$ . The equality in the Clausius inequality holds for totally or just reversible cycle and the inequality for the irreversible ones.

### Reversible Engine

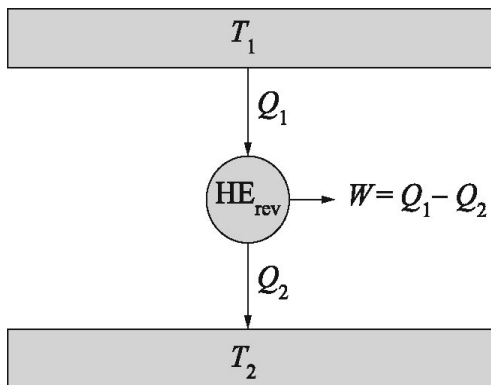

$$\frac{Q_1}{Q_2} = \frac{T_1}{T_2}$$

(or)

$$\frac{Q_1}{T_1} = \frac{Q_2}{T_2}$$

$$\frac{Q_1}{T_1} - \frac{Q_2}{T_2} = 0$$

$$\oint \frac{dQ}{T} = 0$$

### For an Irreversible Engine

$$Q_1 - Q_{2I} < Q_1 - Q_{2R}$$

and therefore

$$Q_{2I} > Q_{2R}$$

Consequently, for an irreversible heat engine

$$\oint \delta Q = Q_1 - Q_{2I} > 0$$

$$\oint \frac{\delta Q}{T} = \frac{Q_1}{T_1} - \frac{Q_{2I}}{T_2} < 0$$

So we conclude that for all irreversible heat engine

$$\oint \frac{\delta Q}{T} < 0$$

### Entropy:

Entropy is defined as  $dS = \left( \frac{\delta Q}{T} \right)_{rev}$

### The T ds Relations:

$$\delta Q_{rev} = dU + \delta W_{rev}$$

$$\text{But } \delta Q_{rev} = TdS$$

$$\text{and } \delta W_{rev} = PdV$$

Thus, The first TdS equation is obtained as

$$TdS = dU + PdV$$

The second TdS equation is obtained by using the definition of enthalpy  $h = u + pv$ .

$$dH = dU + d(PV) = dU + PdV + VdP$$

$$TdS = dH - VdP \quad (\text{Since } TdS = dU + PdV)$$

The  $TdS$  equations can be written on a unit mass basis as

$$Tds = du + PdV$$

$$Tds = dh - v dP$$

## Entropy change of an ideal gas

The entropy change between two states of an ideal gas can be obtained from the ideal gas equation and the combined equation of the first and second laws.

$$Tds = du + Pd v$$

But,  $s_2 - s_1 = c_v \ln \left[ \frac{T_2}{T_1} \right]$   
 $du = c_v dT$  and  $P = (RT)/v$

Therefore,

$$Tds = c_v dT + \left[ \frac{RT}{v} \right] dv$$

or

$$\int_1^2 ds = \int_1^2 c_v \frac{dT}{T} + \int_1^2 R \frac{dv}{v}$$

$$\therefore s_2 - s_1 = c_v \ln \left[ \frac{T_2}{T_1} \right] + R \ln \left[ \frac{v_2}{v_1} \right]$$

Again,  $Tds = dh - v dP$

Now,

$$dh = c_p dT \quad \text{and} \quad v = (RT)/P$$

$$ds = c_p \left[ \frac{dT}{T} \right] - \left[ \frac{RT}{PT} \right] dP$$

$$\int_1^2 ds = \int_1^2 c_p \frac{dT}{T} - R \int_1^2 \frac{dP}{P}$$

$$\therefore s_2 - s_1 = c_p \ln \left[ \frac{T_2}{T_1} \right] - R \ln \left[ \frac{P_2}{P_1} \right]$$

## Entropy change for different process:

Process	Entropy change $s_2 - s_1$
Reversible constant volume process	$s_2 - s_1 = c_v \ln \left[ \frac{T_2}{T_1} \right]$
Reversible constant pressure process	$s_2 - s_1 = c_p \ln \left[ \frac{T_2}{T_1} \right]$



<b>Reversible isothermal process</b>	$s_2 - s_1 = -R \ln \left[ \frac{P_2}{P_1} \right]$ or $s_2 - s_1 = R \ln \left[ \frac{v_2}{v_1} \right]$
<b>Reversible adiabatic process</b>	$s_2 = s_1$
<b>Polytropic process</b>	$\int_1^2 ds = \int_1^2 c_v \left[ \frac{dT}{T} \right] + \int_1^2 R \left[ \frac{dv}{v} \right]$ or $\int_1^2 ds = \int_1^2 c_p \left[ \frac{dT}{T} \right] - R \int_1^2 \left[ \frac{dP}{P} \right]$

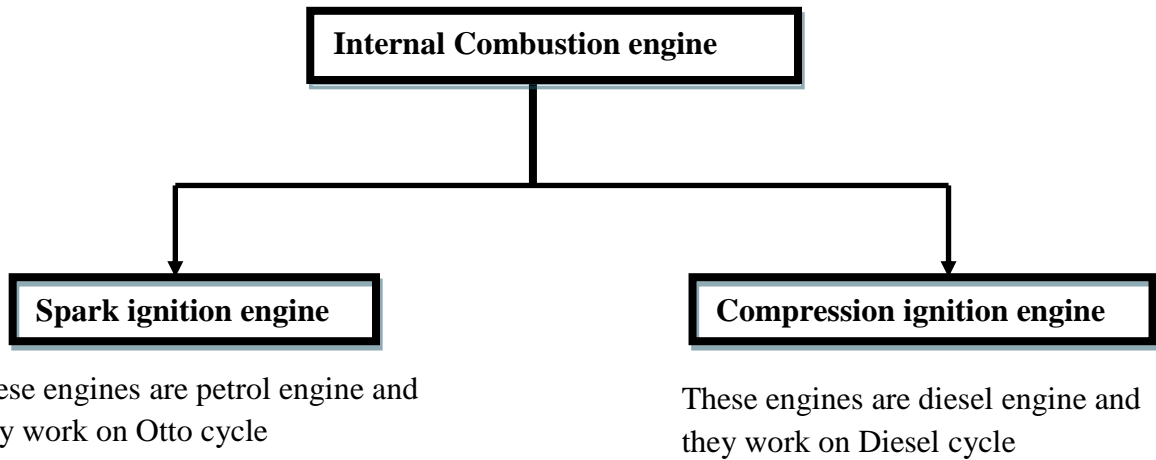

**Basic components of IC engine**

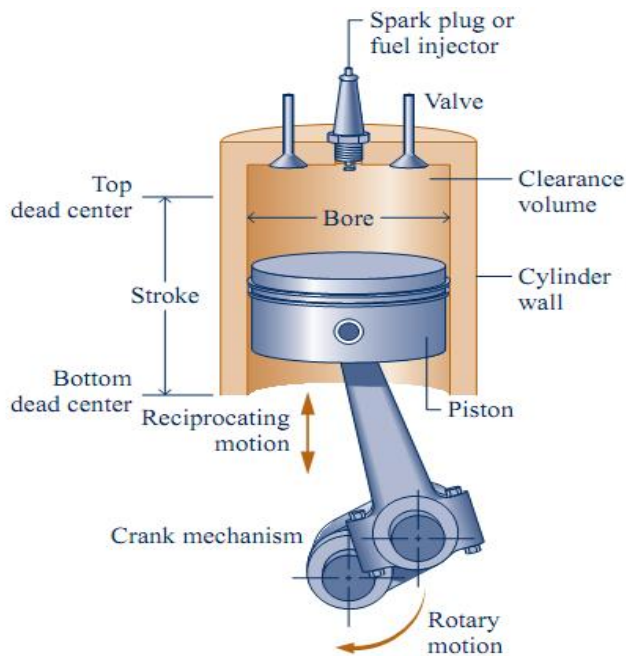

## **Engine Terminology:**

**1. Top Dead Center (TDC):** Position of the piston when it stops at the furthest point away from the crankshaft.

– Top because this position is at the top of the engines (not always), and dead because the piston stops at this point.

– When the piston is at TDC, the volume in the cylinder is a minimum called the clearance volume.

**2. Bottom Dead Center (BDC):** Position of the piston when it stops at the point closest to the crankshaft. Volume of the cylinder is maximum.

**3. Stroke :** Distance traveled by the piston from one extreme position to the other : TDC to BDC or BDC to TDC.

**4. Bore :** It is defined as cylinder diameter or piston face diameter; piston face diameter is same as cylinder diameter (minus small clearance).

**5. Swept volume/Displacement volume :** Volume displaced by the piston as it travels through one stroke.

– Swept volume is defined as stroke times bore.

– Displacement can be given for one cylinder or entire engine (one cylinder times number of cylinders).

**Clearance volume :** It is the minimum volume of the cylinder available for the charge (air or air fuel mixture) when the piston reaches at its outermost point (top dead center or outer dead center) during compression stroke of the cycle.

– Minimum volume of combustion chamber with piston at TDC.

**Compression ratio :** The ratio of total volume to clearance volume of the cylinder is the compression ratio of the engine.

– Typically compression ratio for SI engines varies from 8 to 12 and for CI engines it varies from 12 to 24

## **Otto cycle:**

The processes in Otto cycle are

❖ (1 – 2) Isentropic Compression

❖ (2 – 3) Constant volume heat addition.

❖ (3 – 4) Isentropic Expansion.

❖ (4 – 1) Constant volume heat rejection.

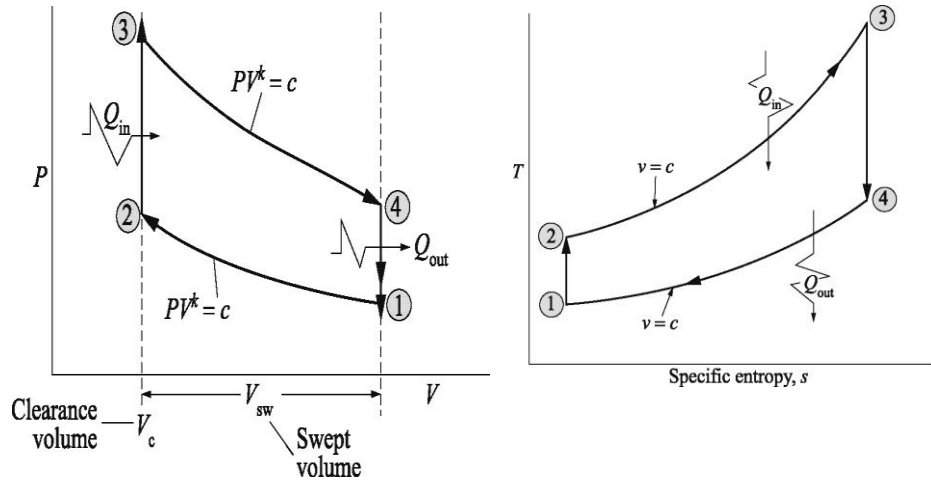

### Efficiency of Otto Cycle

$$\eta_{Oto} = \frac{W_{net}}{\text{Heat Supplied}}$$

$$W_{net} = W_{3-4} - W_{2-1}$$

$$W_{3-4} = C_v (T_3 - T_4) = C_v T_3 \left( 1 - \frac{1}{r_k^{\gamma-1}} \right)$$

$$W_{2-1} = C_v (T_2 - T_1) = C_v T_1 (1 - r_k^{\gamma-1})$$

$$W_{net} = C_p \left( 1 - \frac{1}{r_k^{\gamma-1}} \right) T_3 - T_1 r_k^{\gamma-1}$$

$$\boxed{\eta_{otto} = \left[ 1 - \frac{1}{r_k^{\gamma-1}} \right]}$$

$$\text{Work ratio} = \frac{W_{net}}{W_{turbine}} = 1 - \left[ \frac{T_1}{T_3} \right] r_k^{(\gamma-1)}$$

### Diesel cycle

The processes in Diesel cycle are:

❖ (1 – 2) Isentropic Compression

❖ (2 – 3) Constant pressure heat addition.

❖ (3 – 4) Isentropic Expansion.

❖ (4 – 1) Constant volume heat rejection.

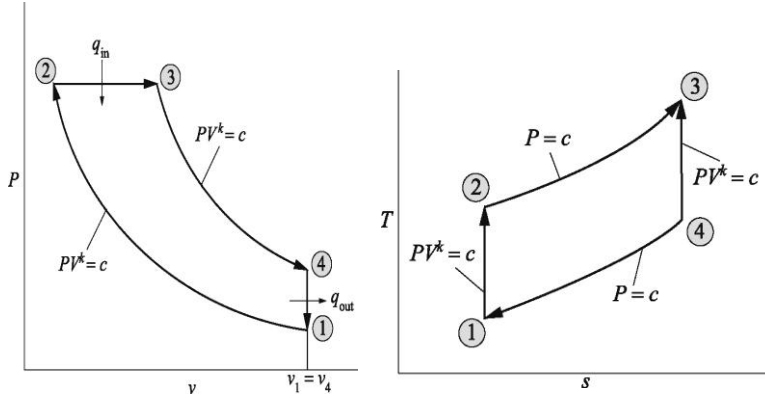

### Efficiency of Diesel cycle

$$\eta_{Diesel} = \frac{W_{net}}{\text{Heat Supplied}} = \frac{q_{in} - q_{out}}{q_{in}}$$

Now  $q_{in} = c_p(T_3 - T_2)$  and  $q_{out} = c_v(T_4 - T_1)$

$$\text{Hence } \eta_{th} = \frac{c_p(T_3 - T_2) - c_v(T_4 - T_1)}{c_p(T_3 - T_2)}$$

$$= 1 - \frac{(T_4 - T_1)}{\gamma(T_3 - T_2)} = 1 - \frac{T_1 \left[ \frac{T_4}{T_1} - 1 \right]}{\gamma T_2 \left[ \frac{T_3}{T_2} - 1 \right]}$$

$$\text{Now } \frac{T_1}{T_2} = \left( \frac{v_2}{v_1} \right)^{\gamma-1} = \left( \frac{1}{r_c} \right)^{\gamma-1}$$

$$\text{Also since } p_3 = p_2, \text{ hence } \frac{T_3}{T_2} = \frac{v_3}{v_2} = \rho$$

where  $\rho$  is the cut-off ratio.

$$\text{Again since } v_4 = v_1, \frac{T_4}{T_1} = \frac{p_4}{p_1} = \rho^\gamma$$

Substituting the values of  $\frac{T_1}{T_2}$ ,  $\frac{T_3}{T_2}$ , and  $\frac{T_4}{T_1}$ , the value of thermal efficiency

$$\eta_{th} = 1 - \left( \frac{1}{r_c} \right)^{\gamma-1} \left[ \frac{\rho^\gamma - 1}{\gamma(\rho - 1)} \right]$$

## Dual cycle:

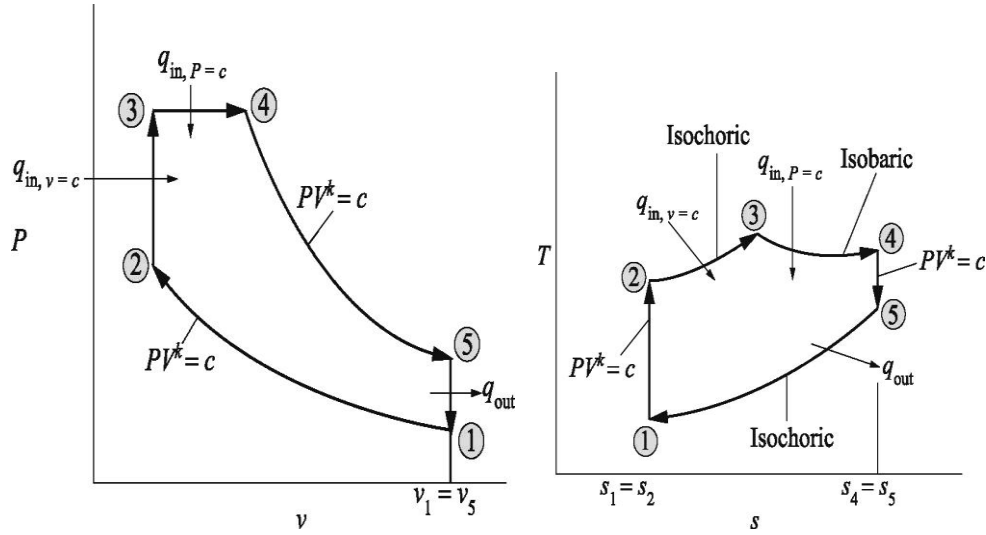

### Processes in Dual cycle:

1. (1-2) Isentropic compression
2. (2-3) Constant volume heat addition
3. (3-4) Constant pressure heat addition
4. (4-1) Isentropic expansion
5. (5-1) Constant volume heat rejection.

### Efficiency of Dual cycle

$$\eta_{dual} = \frac{q_{in} - q_{out}}{q_{in}}$$

$$= \frac{c_v(T_3 - T_2) + c_p(T_4 - T_3) - c_v(T_5 - T_1)}{c_v(T_3 - T_2) + c_p(T_4 - T_3)}$$

$$\eta_{dual} = 1 - \left[ \frac{(T_5 - T_1)}{(T_3 - T_2) + \gamma(T_4 - T_3)} \right]$$

Efficiency,

$$\eta_{Dual} = 1 - \left[ \frac{1}{r_c^{\gamma-1}} \right] \left[ \frac{r_p \rho^\gamma - 1}{(r_p - 1) + \gamma r_p (\rho - 1)} \right]$$

## Comparison between SI engine and CI engine

SI engine	CI engine
Working cycle is Otto cycle.	Working cycle is diesel cycle.
Petrol or gasoline or high octane fuel is used.	Diesel or high cetane fuel is used.
High self-ignition temperature.	Low self-ignition temperature.
Fuel and air introduced as a gaseous mixture in the suction stroke.	Fuel is injected directly into the combustion chamber at high pressure at the end of compression stroke.
Carburettor used to provide the mixture. Throttle controls the quantity of mixture introduced.	Injector and high pressure pump used to supply of fuel. Quantity of fuel regulated in pump.
Use of spark plug for ignition system	Self-ignition by the compression of air which increased the temperature required for combustion
Compression ratio is 6 to 10.5	Compression ratio is 14 to 22
Higher maximum RPM due to lower weight	Lower maximum RPM
Maximum efficiency lower due to lower compression ratio	Higher maximum efficiency due to higher compression ratio
Lighter	Heavier due to higher pressures

### Valve timing diagram

The exact moment at which the inlet and outlet valve opens and closes with reference to the position of the piston and crank shown diagrammatically is known as valve timing diagram. It is expressed in terms of degree crank angle. The theoretical valve timing diagram is shown in Fig.

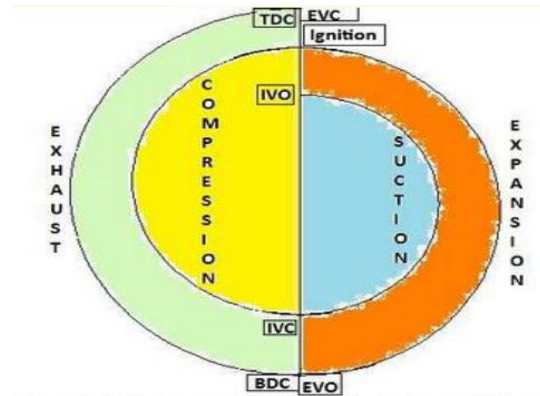

But actual valve timing diagram is different from theoretical due to two factors-mechanical and dynamic factors. Figure 4 shows the actual valve timing diagram for four stroke low speed or high speed engine.

### Opening and closing of inlet valve

- Inlet valve opens 12 to 30° CA before TDC to facilitate silent operation of the engine under high speed. It increases the volumetric efficiency.
- Inlet valve closes 10-60° CA after TDC due to inertia movement of fresh charge into cylinder i.e. ram effect.

Figure represents the actual valve timing diagram for low and high speed engine.

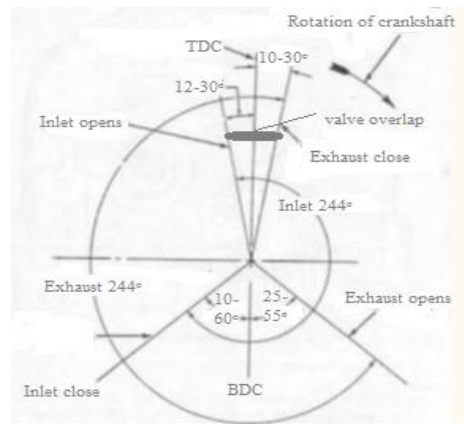

### Opening and closing of exhaust valve

Exhaust valve opens 25 to 55° CA before BDC to reduce the work required to expel out the burnt gases from the cylinder. At the end of expansion stroke, the pressure inside the chamber is high, hence work to expel out the gases increases.

Exhaust valve closes 10 to 30° CA after TDC to avoid the compression of burnt gases in next cycle. Kinetic energy of the burnt gas can assist maximum exhausting of the gas. It also increases the volumetric efficiency.

### **Valve overlap**

During this time both the intake and exhaust valves are open. The intake valve is opened before the exhaust gases have completely left the cylinder, and their considerable velocity assists in drawing in the fresh charge. Engine designers aim to close the exhaust valve just as the fresh charge from the intake valve reaches it, to prevent either loss of fresh charge or unscavenged exhaust gas.